



MACHINE TOOLS



NITTO KOHKI



POWER TOOLS

Electric & Hydraulic Machine Tools, Labor-saving plus Improved Work Efficiency!

*A wide range of unique tools for boring, punching,
beveling and machining.*

MACHINE TOOLS LINE-UP

PORTABLE MAGNETIC BASE DRILLING MACHINE

**ATRA ACE AUTO
ATRA ACE QUICK AUTO
ATRA ACE MANUAL FEED**

TUNGSTEN CARBIDE TIPPED & H.S.S ANNULAR CUTTERS

**JETBROACH
HI-BROACH**

PORTABLE MAGNETIC DRILL STAND

ATRA MASTER

PORTABLE HYDRAULIC PUNCHER

**SELFER ACE HS SERIES
SELFER HA SERIES
HANDY SELFER**

PORTABLE BEVELING TOOL

**HAND BEVELER
MINI BEVELER
CIRCUIT BEVELER**



MACHINE TOOLS CONTENTS

Whether you just glance through this booklet or give it an intensive reading, we are sure you'll agree that NITTO KOHKI's portable hydraulic and electric machines, couplers and pneumatic hand tools are among the finest precision engineered equipment found today.

ONE YEAR LIMITED WARRANTY!

	Manufacturing	Steel Fabricating	Welding	Metal Casting & Forging	Automotive & Ship Building	Construction	Page
PORTABLE MAGNETIC BASE AUTOMATIC DRILLING MACHINE ATRA ACE AUTO (WA-3500/WA-5000)	Speedy, high precision hole drilling	Speedy, high precision hole drilling	—	—	Drilling holes through steel	Drilling holes through shaped steel	7
PORTABLE MAGNETIC BASE AUTOMATIC DRILLING MACHINE ATRA ACE QUICK AUTO AND MANUAL FEED	Speedy, high precision hole drilling	Speedy, high precision hole drilling	—	—	Drilling holes through steel	Drilling holes through shaped steel	8-9
PORTABLE MAGNETIC DRILL STAND ATRA MASTER	Precision drilling through flanges	Drilling	Initial drilling for sheet cutting by welder	Versatile drilling	Various drilling	Drilling through shaped steel, drilling at elevated site	10
ANNULAR CUTTERS BROACH CUTTERS & BROACH HOLDERS	Drilling of large and small diameter holes through steel	Drilling holes through steel	—	—	Drilling holes	Drilling of large and small diameter holes through steel	11-12
PORTABLE DOUBLE ACTING HYDRAULIC PUNCHER SELFER ACE HS SERIES AND HYDRAULIC PUMP	Hole punching through steel plates	Punching bolt holes through steel plates	—	—	Punching holes through ship frameworks	On-site punching holes through shaped steel	13
PORTABLE SINGLE ACTING HYDRAULIC PUNCHER SELFER HA SERIES AND HYDRAULIC PUMP	Hole punching through steel plates	Punching bolt holes through steel plates	—	—	Punching holes through ship frameworks	On-site punching holes through shaped steel	14
ELECTRICALLY OPERATED HYDRAULIC PUNCHER HANDY SELFER PUNCHES AND DIES FOR SELFER	Speedy, easy hole punching through steel sheets	Punching holes through angles and channels	—	—	—	On-site small hole punching	15-16
PORTABLE BEVELING TOOLS BEVELER HAND BEVELER	Beveling of large workpieces	Beveling of steel plates	—	—	—	Beveling of columns	17
TIGON Spring Balancers and Retractors							18

Pneumatic & Electric Power Tools, Labor-saving plus Improved Work Efficiency!

POWER TOOLS

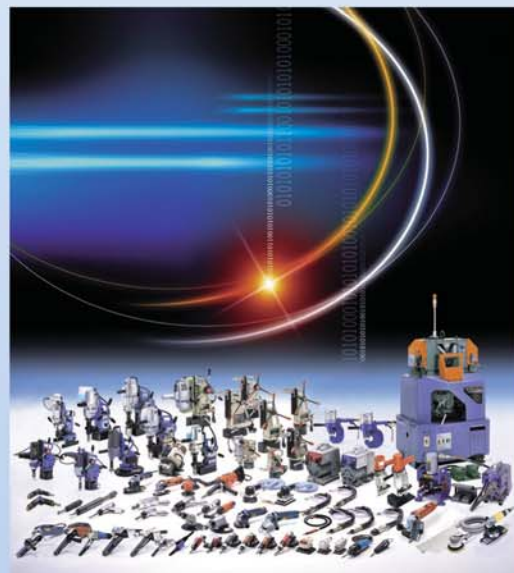

Whether you just glance through this booklet or give it an intensive reading, we are sure you'll agree that NITTO KOHKI's portable hydraulic and electric machines, couplings and pneumatic hand tools are among the finest precision engineered equipment to be found today.

ONE YEAR LIMITED WARRANTY!

	Manufacturing	Sheet-Metal Working		Welding	Painting	Metal Casting & Forging	Automotive & Ship Building	Chemical Engineering	Wood Working & Art	Construction	Page
NEEDLE SCALER JET CHISEL	Various peening works	Paint & rust scaling		Spatter, chips & sludge scaling	-	Sand blasting & chiseling	Rust scaling, welded-part finish	-	-	Surface coarsening of stone and concrete products	19-20
PNEUMATIC SCALER SUPER KELEN	-	-		Spatter, sludge and rust chiseling, scaling	Paint chiseling	Black surface scaling, scaling of ingot remnant in ladle	Removal of weeds, shells, concrete chipping	-	-	Concrete chiseling from framework, removal of linoleum from floor base	21
PNEUMATIC CHIPPING HAMMER AIR CHIPPER	-	-		-	Paint chipping	Sand chipping	Removal of weeds, shells, etc., concrete chipping	-	-	Chipping of stone products	22
PNEUMATIC GRINDER AND SANDER MYTON	Sanding, grinding, chamfering, finishing	Chamfering, rough grinding, mold grinding		Bead grinding, cross section grinding	Grinding of pre-painted surface, buffing	Trimming, chamfering	Additional grinding, rust removal, surface smoothing	-	Sanding	Chamfering of stone products, honing	23-24
PNEUMATIC DIE GRINDER AIR SONIC	Metal working, surface smoothing	Various grinding work		Bead grinding	Pre-painted surface regulation	Mold correction, trimming	Precision grinding of parts	Grinding of pipe cross section and inner surface	Correction grinding of molded products, rough grinding	Additional grinding of construction materials & parts	25-26
PNEUMATIC HAND DRILL AIR DRILL	Various drilling work	Various drilling work		Initial boring for gas cutting by welder	Paint scrambling (w/attachment)	-	Drilling, removal of spot-welded parts	-	Drilling	Sash work	26
PNEUMATIC BELT SANDER BELTON/BABY BELTON	Trimming, chamfering corner rounding	Spot smoothing, surface regulation, finish sanding		Bead grinding, rust removal, chamfering, section finishing	Rough grinding, rust & paint removal, spot smoothing	Trimming, chamfering, spatter grinding, die-cast finishing	Welding chip grinding, finish grinding, fitting	Grinding of pipe & equipment surface face section	Finish sanding of furniture, profile correction of plastic products	Grinding of parts & elements, repair services of tools	27-28
PORTABLE CHAMFERING TOOLS BEVELER	Chamfering of large workpieces	-		Surface chamfering of pre-welded shaped steel parts	Chamfering of steel plate	Chamfering of cast molds	Chamfering of steel plate	-	-	Chamfering of columns (HB-15B)	29-30
PNEUMATIC RADIAL CHAMFERING TOOL CIRCUIT BEVELER	Chamfering of dies and machine	Chamfering of steel plate		-	-	-	-	-	-	Chamfering of steel plate	29-30
PORTABLE PRECISION FINISHING FILE SUPER HAND	Precision filing of flash, chamfering, sanding, groove finishing	Trimming, filing in narrow space, surface regulation		Finish filing	Precision filing of pre-painted surface, sanding	Trimming	Trimming, precision sanding of parts	Filing, superfine filing for profile correction	Filing, superfine filing for profile correction	Correction sanding of metal parts	31
PORTABLE FINE FINISHING FILE MICRO AIR HAND	Precision filing of flash, chamfering, groove finishing	-		-	-	Trimming	Trimming, precision sanding of parts	Filing, superfine filing for profile correction	-	-	32
PNEUMATIC HACKSAW SUPER SAW	Cuts with small radii	Cutting of mild steel plates, aluminum, plastics and other materials		-	-	-	Cutting of body panels of automotive vehicles or shaped steel	Cutting of fiber plates. Cutting of fiber-reinforced plastic plates	-	-	32
HANDY PNEUMATIC SANDER FREE SANDER	Surface sanding, rust & stain removal	Spot smoothing, corner rounding, surface smoothing		-	Sanding of pre-painted, plastered surface, water sanding	Mold correction	Paint sanding of automotive body	Sanding of plastered surface, and test piece surface	Finish sanding, curved surface sanding, sanding of router groove	Sanding of stone products and floor materials	33
PNEUMATIC RECIPROCATING SANDER LINE SANDER	Plane sanding, groove sanding	Spot smoothing, surface regulation		-	Sanding of plastered surface, intermediate finish sanding	Mold correction	Paint sanding of automotive body	Synthetic resin sanding	Rough finish sanding	Inner surface sanding of channeled parts	34
PNEUMATIC DUST-FREE SANDER ORBITAL SANDER	Smoothing, intermediate finish sanding	Surface smoothing of steel products, finishing of pressed products		Surface sanding of pre-welded part	Ground work sanding	Trimming, surface finishing of die-casting	Correction of grinding (finish work)	Precision finishing	Precision sanding	Surface sanding of constructed materials	35
PNEUMATIC COMPACT SANDER PALM ORBITAL SANDER	Smoothing, intermediate finish sanding	Surface smoothing of steel products, finishing of pressed products		Surface sanding of pre-welded part	Ground work sanding	Trimming, surface finishing of die-casting	Correction of grinding (finish work)	Precision finishing	Precision sanding	Surface sanding of constructed materials	35
NOTES ON USING TOOLS – Important Safety Instructions											36
HI CUPLA Series											37
"delvo" Electric Screwdrivers, Linear Motor Driven Free Piston Systems											38



ATRA ACE auto
Model **WA-3500**



ATRA ACE auto
Model **WA-5000**

Max. plate thickness 75mm

High-performance mechanism & high-tech components

One-touch Cutter Replacement

Replacement is quick and easy with our unique push fit self-centering cutter system.



Mounting the cutter Removing the cutter

Improved Bearing Bracket

Our precision bearing bracket aligns cutters precisely, which increases cutter life.



Bearing Bracket

Coolant into the Heart of the Cut

Coolant is fed directly to the inside of the cut. The coolant system also features an auto shut-off.



One-touch Cartridge-type Oil Tank (QA Series)

Our big 24oz cartridge-type oil tank makes it easy to maintain proper coolant levels. There is also an adjustable flow valve on the machine, which allows the user to control the amount of coolant that is being applied to the cutter. Everything on this tool is made to operate quickly and accurately.



Chip Breaker Prevents Cutter from Jamming

Our new chip breaker prevents the cutter from becoming jammed with metal shavings.

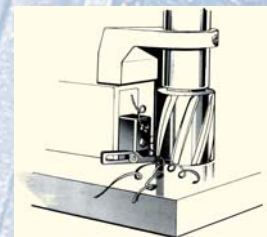

Fail-Safe Protection

Built-in Motion Sensor

If any lateral movement or excess vibration is detected, both the drill and the feed motor stop instantly. Nitto Kohki is the first company to incorporate this feature into magnetic base drills.

Fail-safe Restart

The drill will not re-start even if power is re-supplied after accidental shutdown. Drilling can only be continued after turning on the drill switch.

Magnet Open-circuit Sensor

The drill will not start until the magnetic field is active.

Power Failure Safety

ATRA ACE Automatic Drills temporarily remain on the material after an interruption in power to prevent the drill from spinning off the material. This helps prevent the drill from breaking free from the material and possibly damaging the machine, cutter or even injuring the user.

New drill control prevents cutters from breaking

Slow Start Mechanism

The feed speed is reduced for the first few seconds after boring begins to ensure a smooth cut through the mill scale.

Auto-feed

Automatic control & feed are activated by simply pushing the feed handle to engage the gears.

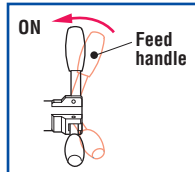

Load Sensor

The dual sensing system responds to both drilling and feeding forces on the cutter for the optimum cutting condition.

Variable Automatic Feed

The feed speed is continuously monitored and updated proportionally to the load on the cutter.

Step Feed

When cutting through difficult materials, the load sensor will automatically activate the Step Feed Program to help penetrate material.

Auto-return Function (QA Series)

Once drilling is completed and the slug is ejected from the hole, the cutting bit is quickly retracted. This quick drill motor retraction allows the user to move on to the next hole more quickly.

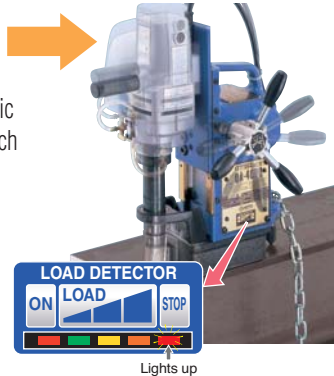

Limit Switch

The ATRA ACE Automatic Drills utilize a limit switch that resets the machine when it retracts to the starting position after hole completion, also shuts down the motors in the event of an over-travel at the bottom of the stroke.

Cycle Stop (WA Series)

After the cut has finished, a detector responds to the reduction in load and both the drill and the feed motor automatically stop.

Overload Stop

When an excessive load is applied to the cutter, both the drill and the feed motor will stop automatically to prevent the cutter from breaking.

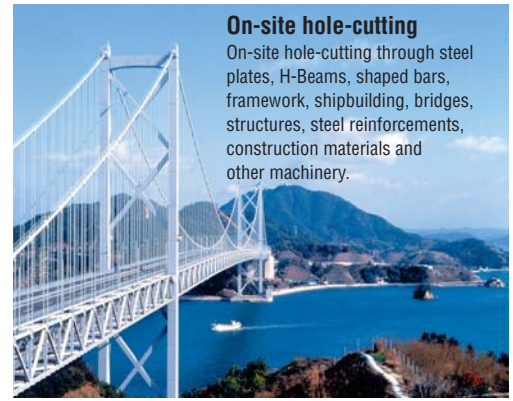
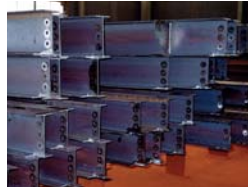

On-site hole-cutting

On-site hole-cutting through steel plates, H-Beams, shaped bars, framework, shipbuilding, bridges, structures, steel reinforcements, construction materials and other machinery.

Automatic-feed Hole-cutting Procedure

- Align the pilot pin with the center punch mark of the hole to be drilled. Attach the machine to the beam with the proper safety chain and engage the magnet. Lower the drill down from the top limit switch location to the point of the pilot pin making contact with the material and engage the motor.



- Engage the clutch by pushing the handles in towards the drill and the motor will begin feeding automatically.

Automatic-feed operation

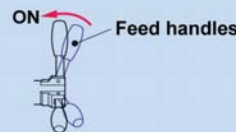

- Slow start mechanism cuts smoothly through the mill scale. Then, speed and feed rate is controlled by the sensors to achieve efficient drilling.



- After the hole is completed, the QA Series machines will quickly return and stop at the top of the stroke, ready for the next hole.



Types of hole-cutting

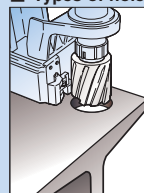

Slanted hole-cutting

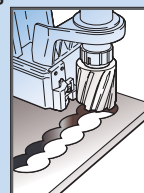

Long hole-cutting

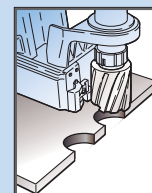

Edge hole-cutting

Nitto Kohki's Atra Ace boosts productivity in the hole drilling industry.



Load Sensor
The dual sensing system responds to both drilling and feeding forces on the cutter for the optimum cutting condition.

Variable Automatic Feed
The feed speed is continuously monitored and updated proportionally to the load on the cutter.

Cycle Stop
After the cut has finished, a detector responds to the reduction in load and both the drill and the feed motor automatically stop.

Load Detection
Side mounted LED graph displays current drill status before, during and after the drilling operation. The load monitoring LEDs also offer advanced notice of worn or damaged cutters.

Auto-return Function
Once drilling is completed and the slug is ejected from the hole, the cutting bit is quickly retracted. This quick drill motor retraction allows the user to move on to the next hole more quickly.

Specifications			WA-3500	WA-5000	QA-4000	QA-5000	QA-6500	
Model			WA-3500	WA-5000	QA-4000	QA-5000	QA-6500	
Power Source (Single Phase)			110-120 V AC 50/60Hz	110-120 V AC 50/60Hz	110-120 V AC 50/60Hz	110-120 V AC 50/60Hz	220-240 V AC 50/60Hz	
Electric	Rated Power Consumption	W	1,100	1,150	680	1,010	1,010	
	Rated Current	A	10.2	10.8	6.1	9	4.5	
	No Load Speed	rpm	950	350 / 650	750	400 / 750	400 / 750	
Magnet Power Consumption			34	75	50	75	75	
Capacity	Hole Diameter		1-3/8" max.	2" max.	1-9/16" max.	2" max.	2-9/16" max.	
	Depth of Cut		2" max.	3" max.	1-3/8" max.	2" max.	2" max.	
Magnet Holding Power			1,583	2,200	1,498	2,200	2,200	
Magnet Dimensions			3-5/8" x 8-1/2"	4" x 8"	3-1/4" x 6-13/16"	3-15/16" x 7-15/16"	3-15/16" x 7-15/16"	
Weight			44	51	41	57	57	
Accessories Included			<ul style="list-style-type: none"> • UEA0835-0 pilot pin 5/16" x 1-3/8" DOC • 3 mm allen wrench • 8 mm x 10 mm combination spanner • Chip guard assembly 	<ul style="list-style-type: none"> • Motor side handle • Sample cutting fluid • Safety chain • Molded plastic carrying case 	<ul style="list-style-type: none"> • UEA0850-0 pilot pin 5/16" x 2" DOC • 3 mm allen wrench • 4 mm allen wrench • 8 mm x 10 mm combination spanner • Chip guard assembly • Motor side handle • Sample cutting fluid • Safety chain • Molded plastic carrying case 	<ul style="list-style-type: none"> • UEA0835-0 pilot pin 5/16" x 1-3/8" DOC • 3 mm allen wrench • 4 mm allen wrench • 8 mm x 10 mm combination spanner • Motor side handle • Sample cutting fluid • Safety chain • Tool box 	<ul style="list-style-type: none"> • UEA0850-0 pilot pin 5/16" x 2" DOC • 3 mm allen wrench • 4 mm allen wrench • 8 mm x 10 mm combination spanner • Motor side handle • Sample cutting fluid • Safety chain • Tool box 	<ul style="list-style-type: none"> • UEA0835-0 pilot pin 5/16" x 1-3/8" DOC • UEA0850-0 pilot pin 5/16" x 2" DOC • 3 mm allen wrench • 4 mm allen wrench • 8 mm x 10 mm combination spanner • Motor side handle • Sample cutting fluid • Safety chain • Tool box

Nitto Kohki's Atra Ace boosts productivity in the hole drilling industry.

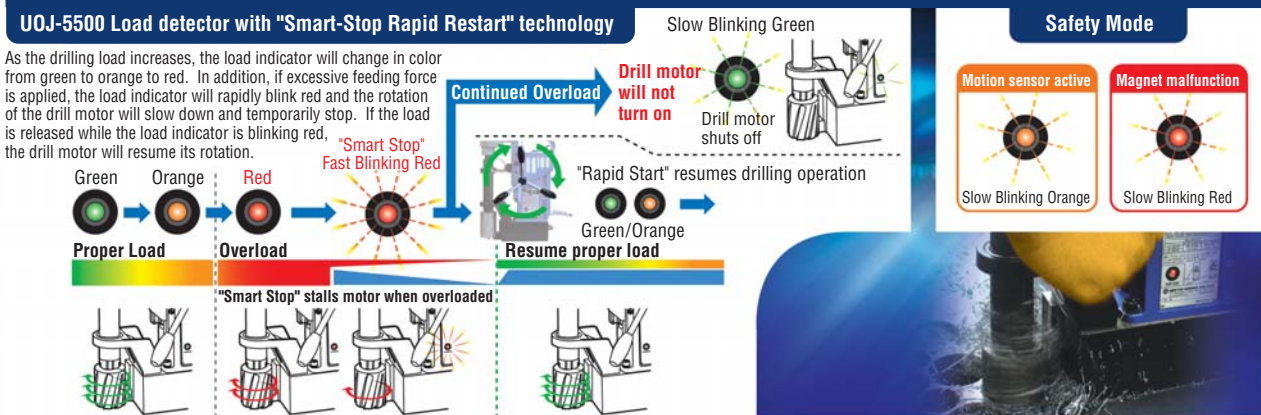

- Especially designed for H.S.S. cutters
- Side-lock version (UO-3500-02) available

Uses Hi-Broach High-speed Steel Annular Cutters



- Smallest and lightest Magnetic Base Drill with 3/8" chuck
- Very easy to handle
- Superior workhorse for drilling small holes with twist drill bits

- Super-duty Magnetic Base Drill to handle up to 4" x 3" capacity
- Morse Taper #3 for versatility
- Smart-Stop/Rapid-Restart function



Specifications

Model	UOJ-3500	UOJ-5500	UO-3500	M-100D	ARA-100A
Power Source (Single Phase)	110-120 V AC 50/60Hz	110-120 V AC 50/60Hz	110-120 V AC 50/60Hz	110-120 V AC 50/60Hz	220-240 V AC 50/60Hz
Electric	Rated Power Consumption	680	1,150	680	390
	Rated Current	6	10.8	6	3.7
	No Load Speed	700	350 / 650	400	1,700
Magnet Power Consumption	32	50	32	35	80
Capacity	Hole Diameter	1-3/8" max.	2-3/16" max.	1-3/8" max.	3/8" max.
	Depth of Cut	2" max.	3" max.	2" max.	4" max.
Twist Drill Capacity	1/2"	N/A	1/2"	3/8"	1-1/4"
Magnet Holding Power	2,023	2,249	2,023	772	3,820
Magnet Dimensions	3-5/32" x 6-3/8"	3-3/8" x 6-11/16"	3-5/32" x 6-3/8"	4-1/8" dia.	4-5/16" x 8-5/8"
Weight	31	40	31	18	66
Accessories Included	<ul style="list-style-type: none"> • UEA0835-0 pilot pin 5/16" x 1-3/8" DOC • 3 mm allen wrench • 5 mm allen wrench • 8 mm x 10 mm combination spanner • Motor side handle • Feed handles (3 each) • Chip guard assembly • Safety chain • Molded plastic carrying case 	<ul style="list-style-type: none"> • UEA0850-0 pilot pin 5/16" x 2" DOC • 3 mm allen wrench • 5 mm allen wrench • 8 mm x 10 mm combination spanner • Motor side handle • Feed handles (3 each) • Chip guard assembly • Safety chain • Molded plastic carrying case • Sample Cutting Fluid 	<ul style="list-style-type: none"> • UEA0825-0 pilot pin 5/16" x 1" DOC • 3 mm allen wrench • 5 mm allen wrench • 8 mm x 10 mm combination spanner • Motor side handle • Feed handles (3 each) • Chip guard assembly • Safety chain • Molded plastic carrying case 	<ul style="list-style-type: none"> • 2.5 mm allen wrench • 7 mm x 8 mm combination spanner • Chuck key (TP08006-0) 	<ul style="list-style-type: none"> • TA9A207-0 pilot pin 3" DOC • Side Handle • 2.5 mm allen wrench • 5 mm allen wrench • 6 mm allen wrench • 8 mm allen wrench • Drift key for Morse Taper #3 • 7 mm x 8 mm combination spanner • Safety Chain • Chip Guard

T.C.T. (Tungsten Carbide Tip) cutters are far superior to conventional H.S.S. or cobalt cutters

JETBROACH One-Touch type

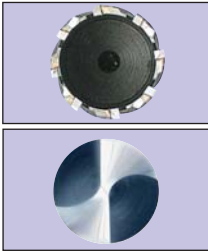
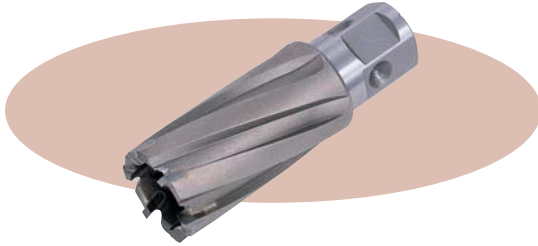

JETBROACH CUTTERS are far better than twist drills:

- No dead point
- Peripheral cutting
- Dramatically reduce cutting resistance
- Available size: 9/16" - 4" diameter

Rationalized Hole-cutting

Genuine one-touch cutters

Nitto Kohki has developed the one-touch replacement system for Jetbroach carbide-tipped annular hole cutters. They are designed to be mounted and removed without the use of a tool. This reduces the time needed to replace cutters.

- Carbide tips for faster cutting
- Single pass cutting, no pilot hole required
- Annular part does all the work so small cutting resistance reduces drilling time
- Cutting of slanted, elongated and edge holes is now possible
- Fractional and metric cutter sizes to suit wide range of applications
- Produces little slag and few chips for easy disposal
- Can also be fitted to and used with previous Atra Ace models using a hexagon socket set-screw
- Improved concentricity extends cutter life!

One-touch system consisting of three balls inside the arbor body produces a self-centering effect during cutting to improve cutter performance and life

Self-centering effect mechanism to extend cutter life

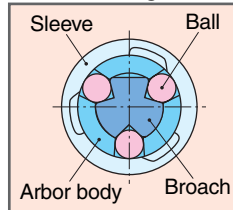

Note:

When holding with a hexagon socket set-screw for fitting to previous Atra Ace models, be sure to tighten not to a dimple but to the flat area (arrow).

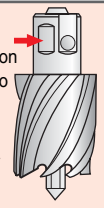

INDUSTRIAL ARBOR



COMBINATION ON HOLDERS AND CUTTERS*

Jetbroach Holder	Part #	Overall Length of Holder (mm)	Up to 35mm Thick Pilot Pin	Up to 50mm Thick Pilot Pin	Up to 75mm Thick Pilot Pin
A BHM-02035 (MT #2)	TB00390-0	163	UEA0835-0		
B BHM-03050 (MT #3)	TB00392-0	182	UEA0835-0	UEA0850-0	
C BHM-13075 (MT #3)	TB00352-0	248			TA9A207-0
D BHM-14075 (MT #4)	TB00354-0	232			TA9A207-0
E BHOR8-00050 (R-8)	TB05943-0		UEA0835-0	UEA0850-0	
F BHR8-00050 (R-8)	TB05891-0		UEA0835-0	UEA0850-0	

*All holders use side-lock shank except for E - #BHOR8-00050, which uses one-touch shank.

Standard Accessories

	A	B	C	D	E	F		A	B	C	D	E	F
Pilot Pin UEA0835-0	•	•			•		Hex Wrench key 6	•	•				•
Pilot Pin TA9A207-0			•	•			Hex Wrench key 8			•	•		

FEED & SPEED

A guide to the selection of circumferential cutting speeds:

	feet/min	m/min
Stainless Steel	65 - 131	20 - 40
Mild Steel	98 - 164	30 - 50
Cast Iron	98 - 164	30 - 50
Brass	164 - 229	50 - 70
Aluminum	229 - 295	70 - 90

Test Drilling is very often the only way to determine the machinability of difficult materials.

Recommended Feed: 0.001"-0.004"/rev. (0.02~0.1 mm/rev.)

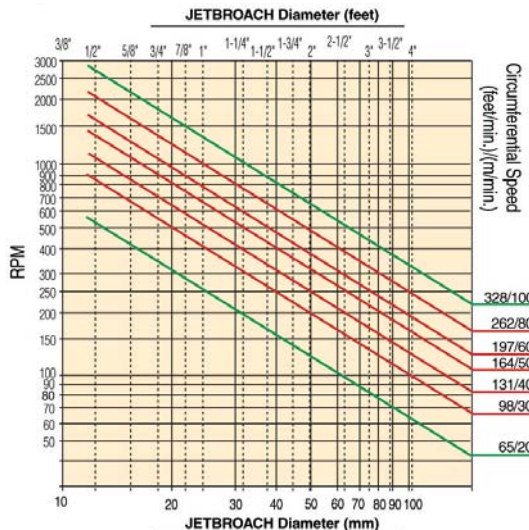

Optional Accessories

Jetbroach Cutter Coolant (1 gal.) TP00234-0



- Nitto's Carbide Cool & Lube maximizes Jetbroach drilling performance and tool life.
- Economical dilution ratio of 10:1 (water:coolant)
- Also available in 55 gallon drum (part # UEACL55-0)

BORING ANNULAR CUTTERS BROACH CUTTERS & BROACH HOLDERS

FRACTIONAL - Inch size					
JETBROACH					
Diameter	Decimal	1-3/8" DOC	2" DOC	3" DOC	4" DOC
9/16"	.563	TK01160*	TK01162**	-	-
5/8"	.625	TK01161*	TK01163**	-	-
11/16"	.687	TK00517	TK00559	TK01037	-
3/4"	.750	TK00518	TK00560	TK00981	-
13/16"	.812	TK00519	TK00561	TK00982	TK00955
7/8"	.875	TK00520	TK00562	TK00983	TK00956
15/16"	.937	TK00521	TK00563	TK00984	TK01056
1"	1.000	TK00522	TK00564	TK00985	TK00958
1-1/16"	1.062	TK00523	TK00567	TK00986	TK01058
1-1/8"	1.125	TK00554	TK00568	TK00987	TK00960
1-3/16"	1.187	TK00555	TK00565	TK00988	TK00947
1-1/4"	1.250	TK00524	TK00569	TK00989	-
1-5/16"	1.312	TK00525	TK00570	TK00990	-
1-3/8"	1.375	TK00526	TK00571	TK00991	-
1-7/16"	1.437	TK00641	TK00572	TK00992	-
1-1/2"	1.500	TK00642	TK00573	TK00993	-
1-9/16"	1.562	TK00643	TK00574	TK00994	-
1-5/8"	1.625	-	TK00575	TK00995	-
1-11/16"	1.687	-	TK00576	TK00996	-
1-3/4"	1.750	-	TK00577	TK00997	-
1-13/16"	1.812	-	TK00578	TK00998	-
1-7/8"	1.875	-	TK00579	TK00999	-
1-15/16"	1.937	-	TK00580	TK01000	-
2"	2.000	-	TK00581	TK01001	-
2-1/16"	2.062	-	TK00644	TK01002	-
2-1/8"	2.125	-	TK00645	TK01094	-
2-3/16"	2.187	-	TK00646	TK01095	-
2-1/4"	2.250	-	TK00647	-	-
2-5/16"	2.312	-	TK00648	-	-
2-3/8"	2.375	-	TK00649	-	-
2-7/16"	2.437	-	TK00650	-	-
2-1/2"	2.500	-	TK00651	-	-
2-9/16"	2.562	-	TK00652	-	-
Pilot Pin		UEA0835	UEA0850	UEA0875	UEA0800

* 9/16" and 5/8" diameter cutters are 1" DOC (Not for use in QA Series)
 * Exception of TK01160 & TK01161 uses UEA0625 (Not for use in QA Series)
 ** Exception of TK01162 & TK01163 uses UEA0650 (Not for use in QA Series)

HI-BROACH (High Speed Steel)			
Diameter	Decimal	1" DOC	2" DOC
7/16"	.437	UK00799*	UK00803*
1/2"	.500	UK00796*	UK00804*
9/16"	.562	TK00582**	TK00805†
5/8"	.625	TK00583**	TK00806†
11/16"	.687	TK00584	TK00808†
3/4"	.750	TK00585	TK00809
13/16"	.812	TK00586	TK00810
7/8"	.875	TK00587	TK00811
15/16"	.937	TK00588	TK00812
1"	1.000	TK00589	TK00813
1-1/16"	1.062	TK00590	TK00814
1-1/8"	1.125	TK00591	TK00815
1-3/16"	1.187	TK00592	TK00816
1-1/4"	1.250	TK00593	TK00817
1-5/16"	1.312	TK00594	TK00818
1-3/8"	1.375	TK00595	TK00819
Pilot Pin		UEA0825	UEA0850

METRIC - mm size									
JETBROACH					JETBROACH				
Diameter	Decimal	1-3/8" DOC	2" DOC	Diameter	Decimal	3" DOC	Diameter	Decimal	3" DOC
17.5	0.689	TK00301	TK00380	50	1.969	TJ17709			
18	0.709	TK00302	TK00381	51	2.008	TJ16651			
18.5	0.728	TK00303	-	52	2.047	TJ16652			
19	0.748	TK00304	TK00382	53	2.087	TJ16653			
19.5	0.767	TK00305	TK00383	54	2.126	TJ16654			
20	0.787	TK00306	TK00384	55	2.165	TJ16655			
20.5	0.807	TK00307	TK00385	56	2.205	TJ16656			
21	0.827	TK00308	TK00386	57	2.244	TJ16657			
21.5	0.846	TK00309	TK00387	58	2.283	TJ16658			
22	0.866	TK00310	TK00388	59	2.323	TJ16659			
22.5	0.885	TK00311	TK00389	60	2.362	TJ16660			
23	0.905	TK00312	TK00390	61	2.402	TJ16661			
23.5	0.925	TK00313	TK00391	62	2.441	TJ16662			
24	0.945	TK00314	TK00392	63	2.480	TJ16663			
24.5	0.965	TK00315	TK00393	64	2.520	TJ16664			
25	0.984	TK00316	TK00394	65	2.559	TJ16665			
26	1.023	TK00317	TK00395	66	2.598	TJ16666			
26.5	1.043	TK00318	TK00396	67	2.638	TJ16667			
27	1.063	TK00319	TK00397	68	2.677	TJ16668			
28	1.102	TK00320	TK00398	69	2.717	TJ16669			
29	1.141	TK00321	TK00399	70	2.756	TJ16670			
30	1.181	TK00322	TK00400	71	2.795	TJ16671			
31	1.220	TK00323	TK00401	72	2.835	TJ16672			
32	1.259	TK00324	TK00402	73	2.874	TJ16673			
33	1.299	TK00325	TK00403	74	2.913	TJ16674			
34	1.338	TK00326	TK00404	75	2.953	TJ16675			
35	1.378	TK00328	TK00405	76	2.992	TJ16676			
36	1.417	TK00602	TK00406	77	3.031	TJ16677			
37	1.456	TK00603	TK00407	78	3.071	TJ16678			
38	1.496	TK00604	TK00408	79	3.110	TJ16679			
39	1.535	TK00605	TK00409	80	3.150	TJ16680			
40	1.575	TK00606	TK00410	81	3.189	TJ16681			
41	1.614	-	TK00411	82	3.228	TJ16682			
42	1.654	-	TK00412	83	3.268	TJ16683			
43	1.693	-	TK00413	84	3.307	TJ16684			
44	1.732	-	TK00414	85	3.346	TJ16685			
45	1.772	-	TK00415	86	3.386	TJ16686			
46	1.811	-	TK00416	87	3.425	TJ16687			
47	1.850	-	TK00417	88	3.465	TJ16688			
48	1.890	-	TK00418	89	3.504	TJ16689			
49	1.929	-	TK00419	90	3.543	TJ16690			
50	1.969	-	TK00420	91	3.583	TJ16691			
51	2.008	-	TK00442	92	3.622	TJ16692			
52	2.047	-	TK00443	93	3.661	TJ16693			
53	2.087	-	TK00444	94	3.701	TJ16694			
54	2.126	-	TK00445	95	3.740	TJ16695			
55	2.165	-	TK00446	96	3.780	TJ16696			
56	2.205	-	TK00447	97	3.819	TJ16697			
57	2.244	-	TK00448	98	3.858	TJ16698			
58	2.283	-	TK00449	99	3.898	TJ16699			
59	2.323	-	TK00450	100	3.937	TJ16700			
60	2.362	-	TK00451						
61	2.402	-	TK00607	Pilot Pin		TA9A207			
62	2.441	-	TK00608						
63	2.480	-	TK00609						
64	2.520	-	TK00610						
65	2.559	-	TK00611						
Pilot Pin		UEA0835	UEA0850						

Hi-Broach metric sizes available upon request.

* UK number cutter comes with pilot pin
 ** Exception of TK00582 & TK00583 uses UEA0625
 † Exception of TK00805, TK00806 & TK00808 uses UEA0650

Double-acting hydraulic system allows automatic and inching (manual mode) operation.

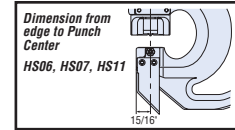

SELFER ACE
Model **HS11-1624**

18.21" (462.5mm)

15.16" (385mm)

- Max. Punching Diameter : 1-1/16"
- Max. Punching Thickness : 5/8" *
1/4" for 304 Stainless Steel
- Max. Output : 52 tons

SELFER ACE
Model **HS07-1624**

16.95" (430.5mm)

14.29" (363mm)

- Max. Punching Diameter : 15/16"
- Max. Punching Thickness : 5/8" *
1/4" for 304 Stainless Steel
- Max. Output : 52 tons

SELFER ACE
Model **HS06-1322**

16.65" (423mm)

12.72" (323mm)

- Max. Punching Diameter : 7/8"
- Max. Punching Thickness : 1/2" *
1/4" for 304 Stainless Steel
- Max. Output : 41 tons

* 1" and 1-1/16" punch requires the use of a split lock nut (UHA9936-0) and reduces the maximum thickness to 9/16"

Specifications

In case of mild steel maximum punching thickness must be decided based on the equation of 0.8 x punching diameter. For details see the instruction manual.

Model	HS11-1624	HS07-1624	HS06-1322
Max. Throat Depth	4-5/16"	2-3/4"	2-3/8"
Hole Making Time	Punching Time 11.8 sec. Returning Time 5.7 sec.	Punching Time 11.8 sec. Returning Time 5.7 sec.	Punching Time 7.9 sec. Returning Time 3.4 sec.
Allowable Max. Pressure	10,000 psi	10,000 psi	10,000 psi
Weight	66 lbs.	56 lbs.	45 lbs.
Accessories Included	• Hose Kit Assembly • Hose Cord Assembly • Spanner • Spanner 12 • Sub Handle Assembly • Chip Guard Ass'y • Tool Box • 22 mm Punch & Die mounted on machine • 4mm Allen Wrench • 5mm Allen Wrench		

Optional Accessories



UHA9936-0 Split Lock Nut
for 1" and 1-1/16" Punch



TA99037-0 Lock Nut Assembly
for 25 mm Punch



Part #TW-40
Spring Balancer
for HS11/HS07



Part #TW-30
Spring Balancer
for HS06

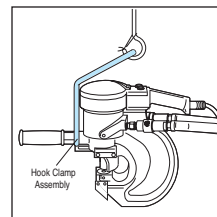

Part #TB02142-0
Hook Clamp Assembly



Part #TB02141-0
Foot Switch Relay
Assembly

HYDRAULIC PUMP for HS Type
Model **HPD-05**
Double-Acting

16.34" (415mm)

16.79" (426.4mm)

Specifications

Model	HPD-05
Power Source (Single Phase)	110-120V AC
Max. Output Pressure	10,000 psi
Output At No Load	1.53 qt/min
Output AT 10,000 psi	0.7 qt/min
Motor	0.4 kw 4p
Reservoir Capacity	4.26 qt
Discharge Port	Rc 3/8 (PT 3/8")
Weight	63 lbs.

230V available upon request

**Punch and return operations are fully automatic.
An emergency switch returns the punch at any time.**

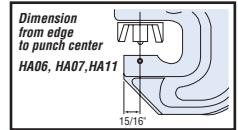

SELFER
Model **HA11-1624**

21.5" (545.6mm) | 17.17" (436mm)

- Max. Punching Diameter : 1-1/16"
- Max. Punching Thickness : 5/8"*
- Max. Output : 49 tons

SELFER
Model **HA07-1624**

21.5" (545.6mm) | 16.46" (418mm)

- Max. Punching Diameter : 15/16"
- Max. Punching Thickness : 5/8"
- Max. Output : 49 tons

SELFER
Model **HA06-1322**

20.63" (524.1mm) | 15" (381mm)

- Max. Punching Diameter : 7/8"
- Max. Punching Thickness : 1/2"
- Max. Output : 34 tons

* 1" and 1-1/16" punch requires the use of a split lock nut (UHA9936-0) and reduces the maximum thickness to 9/16"

Specifications

In case of mild steel maximum punching thickness must be decided based on the equation of 0.8 x punching diameter. For details see the instruction manual.

Model	HA11-1624	HA07-1624	HA06-1322
Max. Throat Depth	4-5/16"	2-3/4"	2-3/8"
Hole Making Time	Punching Time 16.5 sec. Returning Time 1 sec.	Punching Time 16.5 sec. Returning Time 1 sec.	Punching Time 10.5 sec. Returning Time 1 sec.
Allowable Max. Pressure	10,000 psi	10,000 psi	10,000 psi
Weight	78 lbs.	63 lbs.	47 lbs.
Accessories Included	<ul style="list-style-type: none"> Hose Cord Assembly • Spanner • Sub Handle Assembly • Tool Box 22 mm Punch & Die mounted on machine • 4mm Allen Wrench 		

Optional Accessories



UHA9936-0 Split Lock Nut
for 1" and 1-1/16" Punch



TA99037-0 Lock Nut Assembly
for 25 mm Punch



Part #TW-40 Spring Balancer
for HA11/HA07



Part #TW-30 Spring Balancer
for HA06

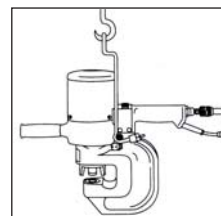

Part #TA96342-0 Hook Clamp Assembly



Part #TA94386-0 Foot Switch Assembly

HYDRAULIC PUMP for HA Type
Model **SC-05**
Single-Acting

14.96" (380mm) | 12.76" (324mm)

Specifications

Model	SC-05
Power Source (Single Phase)	110-120V AC
Max. Output Pressure	10,000 psi
Output At No Load	1.28 qt/min
Output At 10,000 psi	0.59 qt/min
Motor	0.4 kw 4p
Reservoir Capacity	4.26 qt
Discharge Port	Rc 3/8 (PT 3/8")
Weight	60 lbs.

230V available upon request

Self-contained hydraulic punch shows its power in making round or elongated holes in flat bar, angle bar or channel iron.

HANDY SELFER
Model **E55-0619**



Max. Punching Diameter: 13/16"
Max. Punching Thickness: 1/4"
Max. Output: 17 tons

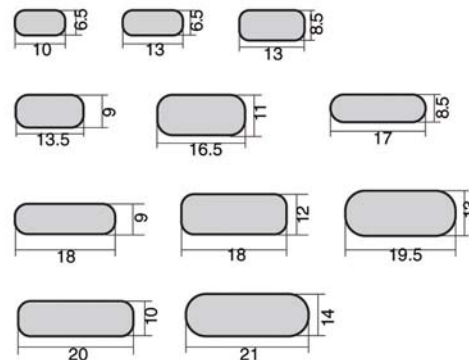

Custom shape and size punches and dies available upon request

Specifications

Model	E55-0619
Power Source (Single Phase)	110-120V AC 50/60 Hz
Rated Power Consumption	670 W
Rated Current	7.0 A
Max. Punching Diameter	13/16"
Max. Punching Thickness	1/4"
Max. Throat Depth	2-3/16"
Punching Time	2 sec.
Weight	31 lbs
Accessories Included	<ul style="list-style-type: none"> • 3 mm / 4 mm / 5 mm Allen Wrench • Stand Assembly • EL Punch 18 / EL Die 18B / EL Die 18A Mounted on Machine • Spanner 10 x 12

Selection of Dies

Application	Type of Die	Plate Thickness	
		Mild Steel	Stainless Steel
For thin sheets	A	1/16" – 1/8"	Max. 1/8"
For thick sheets	B	5/32" – 1/4"	Max. 5/32"
For channel iron	C	9/32" – 5/16"	N.A.

Optional Accessories



Foot Switch Assembly
TB00799-0

Punches & Dies for SELFER Puncher

For HS and HA Series SELFER ACE			
FRACTIONAL - Inch Round Size			
Diameter	Decimal	Punch	Die
5/16"	0.313	UHP0516	UHD0516
3/8"	0.375	UHP0308	UHD0308
7/16"	0.438	UHP0716	UHD0716
1/2"	0.500	UHP0102	UHD0102
9/16"	0.563	UHP0916	UHD0916
5/8"	0.625	UHP0508	UHD0508
11/16"	0.688	UHP1116	UHD1116
3/4"	0.750	UHP0304	UHD0304
13/16"	0.813	UHP1316	UHD1316
7/8"	0.875	UHP0708	UHD0708
15/16"	0.938	UHP1516	UHD1516
**1"	1.000	UHP0101	UHD0101
**1-1/16"	1.063	UHP1716	UHD1716

**1" and 1-1/16" require part # UHA9936 split lock nut

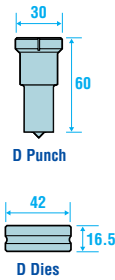

For HS and HA Series SELFER ACE			
METRIC - mm Round Size			
Diameter	Decimal	Punch	Die
8	0.315	TJ10778	TJ10779
9	0.354	TJ11088	TJ11089
10	0.394	TJ06700	TJ06701
11	0.433	TJ06698	TJ06699
12	0.472	TJ06696	TJ06697
13	0.512	TJ06694	TJ06695
14	0.551	TJ06692	TJ06693
14.5	0.571	TJ06611	TJ06612
15	0.591	TJ06690	TJ06691
16	0.630	TJ06688	TJ06689
17	0.669	TJ06686	TJ06687
17.5	0.689	TJ06609	TJ06610
18	0.709	TJ06684	TJ06685
18.5	0.728	TJ08578	TJ08579
19	0.748	TJ06682	TJ06683
20	0.787	TJ06680	TJ06681
20.5	0.807	TJ06607	TJ06608
21	0.827	TJ06678	TJ06679
21.5	0.846	TJ07979	TJ07980
22	0.866	TJ06676	TJ06677
22.5	0.886	TJ09552	TJ09553
23	0.906	TJ06674	TJ06675
23.5	0.925	TJ06566	TJ06569
24	0.945	TJ07748	TJ07749
*25	0.984	TJ10061	TJ10062

*25 mm requires part # TA99037 oversized lock nut

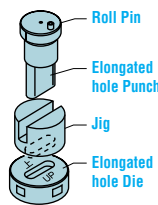
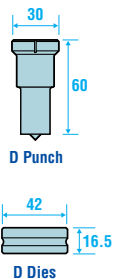

For HS and HA Series SELFER ACE				
METRIC - mm Oblong Size				
Size	Decimal	Punch	Die	Jig
16 x 8	0.630 x 0.315	TJ13229	TJ13238	TK00455
18 x 9	0.709 x 0.354	TJ13230	TJ13239	TK00456
20 x 10	0.787 x 0.394	TJ13231	TJ13240	TK00457
20 x 14	0.787 x 0.551	TJ14973	TJ14974	TK00469
22 x 11	0.866 x 0.433	TJ13232	TJ13241	TK00458
22 x 14	0.866 x 0.551	TJ13262	TJ13263	TK00464
24 x 12	0.945 x 0.472	TJ13233	TJ13242	TK00459
*25 x 9	0.984 x 0.354	TJ13234	TJ13243	TK00460
*25 x 12	0.984 x 0.472	TJ13235	TJ13244	TK00461
*25 x 14	0.984 x 0.551	TJ13236	TJ13245	TK00462
*25 x 18	0.984 x 0.709	TJ13237	TJ13246	TK00463

*25 mm size requires part # TA99037 oversized lock nut

Punches & Dies for HANDY SELFER

For E55-0619 HANDY SELFER					
FRACTIONAL - Inch Round Size					
Diameter	Decimal	Punch	"A" Die	"B" Die	"C" Die
1/4	0.250	E5P0104-0	E5D0104-A	E5D0104-B	-
5/16	0.313	E5P0516-0	E5D0516-A	E5D0516-B	-
3/8	0.375	E5P0308-0	E5D0308-A	E5D0308-B	E5D0308-C
7/16	0.438	E5P0716-0	E5D0716-A	E5D0716-B	E5D0716-C
1/2	0.500	E5P0102-0	E5D0102-A	E5D0102-B	E5D0102-C
9/16	0.563	E5P0916-0	E5D0916-A	E5D0916-B	E5D0916-C
5/8	0.625	E5P0508-0	E5D0508-A	E5D0508-B	E5D0508-C
11/16	0.688	E5P1116-0	E5D1116-A	E5D1116-B	-
3/4	0.750	E5P0304-0	E5D0304-A	E5D0304-B	-
13/16	0.813	E5P1316-0	E5D1316-A	E5D1316-B	-

"A" Die for 1/16" thru 1/8" mild steel
 "B" Die for 5/32" thru 1/4" mild steel
 "C" Die for 9/32" thru 5/16" mild steel/C-channel

For E55-0619 HANDY SELFER					
METRIC - mm Round Size					
Diameter	Decimal	Punch	"A" Die	"B" Die	"C" Die
6	0.236	TK00193	TK00208	TK00222	-
6.5	0.256	TK00194	TK00209	TK00223	-
8	0.315	TK00195	TK00210	TK00224	-
8.5	0.335	TK00196	TK00211	TK00225	-
10	0.394	TK00197	TK00212	TK00226	TK00235
11	0.433	TK00198	TK00213	TK00227	TK00236
12	0.472	TK00199	TK00214	TK00228	TK00237
13	0.512	TK00200	TK00215	TK00229	TK00238
14	0.551	TK00201	TK00216	TK00230	TK00239
15	0.591	TK00202	TK00217	TK00231	TK00240
16	0.630	TK00203	TK00218	TK00232	TK00241
17	0.669	TK00204	TK00219	TK00233	-
18	0.709	TK00205	TK00220	TK00234	-
18.5	0.728	TK00278	TK00279	TK00280	-
19	0.748	TK00180	TK00181	TK00182	-

"A" Die for 1/16" thru 1/8" mild steel
 "B" Die for 5/32" thru 1/4" mild steel
 "C" Die for 9/32" thru 5/16" mild steel/C-channel

For E55-0619 HANDY SELFER				
METRIC - mm Oblong Size				
Size	Decimal	Punch	"A" Die	"B" Die
10 x 6.5	0.394 x 0.256	TK00242	TK00254	TK00266
13 x 6.5	0.512 x 0.256	TK00243	TK00255	TK00267
13 x 8.5	0.512 x 0.335	TK00244	TK00256	TK00268
13.5 x 9	0.531 x 0.354	TK00245	TK00257	TK00269
15 x 10	0.591 x 0.394	TK00246	TK00258	TK00270
16.5 x 11	0.650 x 0.433	TK00247	TK00259	TK00271
17 x 8.5	0.669 x 0.335	TK00248	TK00260	TK00272
18 x 9	0.709 x 0.354	TK00249	TK00261	TK00273
18 x 12	0.709 x 0.472	TK00250	TK00262	TK00274
19.5 x 13	0.768 x 0.512	TK00251	TK00263	TK00275
20 x 10	0.787 x 0.394	TK00252	TK00264	TK00276
21 x 14	0.827 x 0.551	TK00253	TK00265	TK00277

"A" Die for 1/16" thru 1/8" mild steel
 "B" Die for 5/32" thru 1/4" mild steel

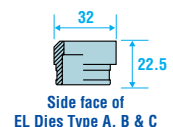
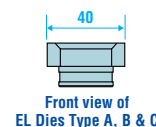
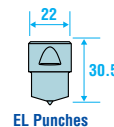

Custom shape and size punches and dies for SELFER ACE, SELFER, and HANDY SELFER available upon request.

HAND BEVELER HB-15B *Chamfering up to 15C*



Features

- Ideal for plate, pipe, and tube beveling for welding preparation
- Bevels angles 15° to 45°
- Bevels depth up to 5/8" (15 mm) at 45° angle using multiple passes
- Bevels approximately 3' to 4' per minute
- High speed cutting action minimizes material hardening

Chamfering steel plates



Chamfering I-beams

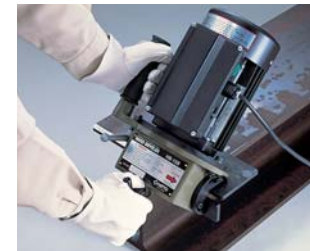

Specifications

Model	HB-15B
Power Supply	115V AC, 50/60 Hz
Rated Power Consumption	910 W
Rated Current	10.5 A
No Load Speed	3,340 RPM
Chamfering Capacity (Mild Steel)	5/8" (15 mm) Depth at 45° Angle
Chamfer Angle	15° – 45°
Power Cord	13.1 feet (4 meters)
Weight	33 lbs
Accessories Included	<ul style="list-style-type: none"> • 4 mm Allen Wrench • 5 mm Allen Wrench • 6 mm Allen Wrench • Hook Spanner 25-28 • Spanner 24 mm x 27 mm • 3mm T Wrench • Roller Bracket Assembly • 2 Sets of Cutting Tips, Comes with One Set Mounted (12 pieces/set)
Optional Accessories	<ul style="list-style-type: none"> • TA9A728 Pipe and Tube Beveling Attachment Capacity 7-7/8" to 32" inches O.D. • TA9A093 Cutting Tips (12 pieces/set)

Chamfer angle and width

Chamfer Angle α	HB-15B Mild Steel(mm)		Chamfer	
	X	Y		
45°	15	15		
30°	9	15.5		
15°	4	15.4		

Spring Balancers

TIGON Spring Balancer Improves Work Safety & Efficiency

Capacities ranging from 1.1 - 154.3 lbs. (0.5 - 70 kg.)

Model	Capacity		Stroke		Weight	
	lbs.	kg	feet	m	lbs.	kg
TW-00	1.1-3.3	0.5-1.5	1.64	0.5	0.4	0.2
TW-0	1.1-3.3	0.5-1.5	3.28	1.0	1.1	0.5
TW-3	2.2-6.6	1.0-3.0	4.27	1.3	3.1	1.4
TW-5	5.5-11.0	2.5-5.0	4.27	1.3	3.3	1.5
TW-9	9.9-19.8	4.5-9.0	4.27	1.3	7.5	3.4
TW-15	19.8-33.1	9.0-15.0	4.27	1.3	8.4	3.8
TW-22	33.1-48.5	15.0-22.0	4.92	1.5	15.9	7.2
TW-30	48.5-66.1	22.0-30.0	4.92	1.5	16.8	7.6
TW-40	66.1-88.2	30.0-40.0	4.92	1.5	21.6	9.8
TW-50	88.2-110.3	40.0-50.0	4.92	1.5	22.9	10.4
TW-60	110.3-132.3	50.0-60.0	4.92	1.5	25.6	11.6
TW-70	132.3-154.3	60.0-70.0	4.92	1.5	26.0	11.8



Hose Reel Balancers

Incorporates both balancer and hose reel

Model	Capacity		Stroke		Weight		Hose Diameter (mm)	
	lbs.	kg	feet	m	lbs.	kg	I.D.	O.D.
HW-0	1.1-3.3	0.5-1.5	4.27	1.3	3.5	1.6	6.5	10
HW-3	3.3-6.6	1.5-3.0	4.27	1.3	3.8	1.7	6.5	10
HW-5	6.6-11.0	3.0-5.0	4.27	1.3	4.0	1.8	6.5	10



Retractors

Handy knob for easy tension adjustment

Model	Capacity		Stroke		Weight	
	lbs.	kg	feet	m	lbs.	kg
RW-0	1.1-3.3	0.5-1.5	6.56	2.0	1.1	0.5
RW-3	2.2-6.6	1.0-3.0	6.56	2.0	1.5	0.7
RW-5	5.5-11.0	2.5-5.0	6.56	2.0	2.0	0.9



Model	Capacity		Stroke		Weight	
	lbs.	kg	feet	m	lbs.	kg
TW-06R	0.4-1.3	0.2-0.6	4.92	1.5	0.66	0.3
TW-1R	1.1-3.3	0.5-1.5	4.92	1.5	0.66	0.3

JET CHISEL

**Powerful scaling
with multiple needles**



Features

- Quickly and efficiently removes weld slag, rust, paint and scale from most surfaces.
- Ideal for cleaning and descaling steel, bridge-work, castings, brick, stone and many other materials.
- Heavy-duty construction for industrial and maritime applications.
- Proven superior design features with no internal spring components ensures trouble-free performance.

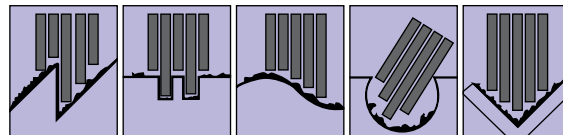

Shot Peening Effect

Reinforcement of a welded part with the shot peening effect increases strength by imparting residual stress to the surface of the workpiece through the high speed impact of the needles. Highly suitable for effective reinforcement of deteriorated welded parts.

Fully Automatic System

The only unit of its kind on the market without springs. This means no springs to break...no irregular power... and the advantage of low air consumption.

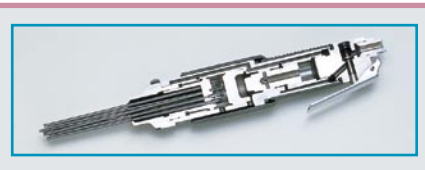

AJC-16 Slim Model

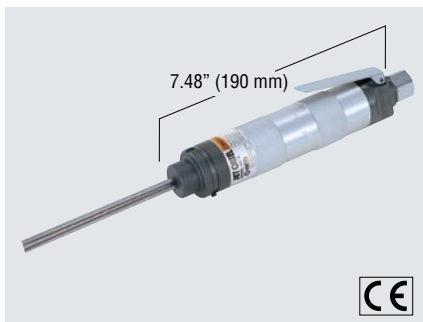

JT-20 Medium-Duty Model

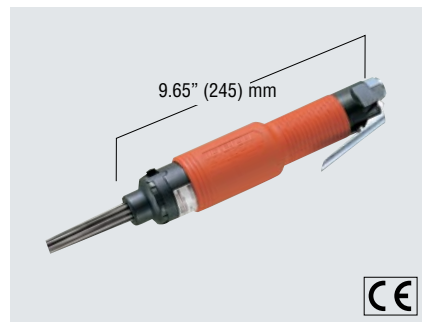

JEX-20 Reduced Vibration Model

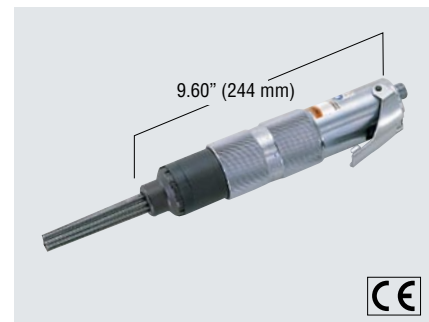

Specifications

Model	AJC-16	JT-20	JEX-20
Air Pressure	85 PSI	85 PSI	85 PSI
Air Consumption	2.6 CFM	7.1 CFM	7.1 CFM
Strokes per Minute	6,000 SPM	4,000 SPM	4,000 SPM
Standard Needles with Machine	3 pieces of 3 mm x 180 mm	12 pieces of 3 mm x 180 mm	12 pieces of 3 mm x 180 mm
Optional Needle Size	N/A	29 pieces of 2 mm x 180 mm	29 pieces of 2 mm x 180 mm
Hose Size	3/8" ID	3/8" ID	3/8" ID
Weight	2.2 lbs.	5.3 lbs.	6.1 lbs.

Accessories Included	AJC-16	JT-20	JEX-20
	• Threaded Adapter PT3/8" x NPT3/8" • Hose Nipple PT3/8" x 3/8"	• Threaded Adapter PT3/8" x NPT3/8" • Hose Nipple PT3/8" x 3/8"	• Threaded Adapter PT3/8" x NPT3/8" • Hose Nipple PT3/8" x 3/8"

SCALING

NEEDLE SCALER JET CHISEL

JC-16

Lightweight Model

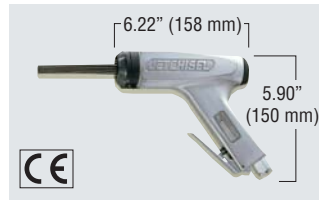

JEX-24

Medium-duty Model



JEX-28

Heavy-duty Model

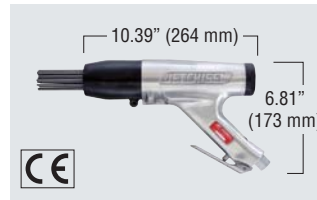

JEX-2800A

Reduced Vibration Model



Specifications

Model	JC-16	JEX-24	JEX-28	JEX-2800A
Air Pressure	85 PSI	85 PSI	85 PSI	85 PSI
Air Consumption	5.3 CFM	9.5 CFM	12.4 CFM	15.2 CFM
Strokes per Minute	4,000 SPM	4,000 SPM	4,500 SPM	3,700 SPM
Standard Needles with Machine	29 pieces of 2 mm x 180 mm	23 pieces of 3 mm x 180 mm	28 pieces of 3 mm x 180 mm	28 pieces of 3 mm x 180 mm
Optional Needle Size	N/A	53 pieces of 2 mm x 180 mm 12 pieces of 4 mm x 180 mm	66 pieces of 2 mm x 180 mm 14 pieces of 4 mm x 180 mm	66 pieces of 2 mm x 180 mm 14 pieces of 4 mm x 180 mm
Hose Size	3/8" I.D.	3/8" I.D.	3/8" I.D.	3/8" I.D.
Weight	3.1 lbs.	6.1 lbs.	7.7 lbs.	6.8 lbs.
Accessories Included	<ul style="list-style-type: none"> Threaded Adapter PT3/8" x NPT3/8" Hose Nipple PT3/8" x 3/8" 	<ul style="list-style-type: none"> Threaded Adapter PT3/8" x NPT3/8" Hose Nipple PT3/8" x 3/8" 6mm Allen Wrench 	<ul style="list-style-type: none"> Threaded Adapter PT3/8" x NPT3/8" Hose Nipple PT3/8" x 3/8" TP01462 Needle Supporter 4mm 14 pieces of 4mm x 180mm Needles 6mm Allen Wrench 	<ul style="list-style-type: none"> Threaded Adapter PT3/8" x NPT3/8" Hose Nipple PT3/8" x 3/8" TP01462 Needle Supporter 4mm 14 pieces of 4mm x 180mm Needles

Electric Needle Scaler

EJC-32A



Accessories Included	<ul style="list-style-type: none"> 15 pieces of 3 mm x 180 mm Needles 6mm Allen Wrench
----------------------	--

- Overload protection
- Powerful 300 watt double insulated motor
- Extended length, slim barrel design
- Adjustable front handle for operator comfort and convenience

Specifications

Model	EJC-32A	
Power Supply	115 V AC, 50/60 Hz	230 V AC, 50/60 Hz
Rated Power Consumption	300 watts	300 watts
Rated Current	2.8 A	1.4 A
Rated Duty Cycle	30 minutes	
Strokes per Minute	3,000 SPM	
Standard Needles with Machine	15 pieces of 3 mm x 180 mm	
Optional Needle Size	32 pieces of 2 mm x 180 mm	
Power Cord Length	6-1/2 feet (5 meters)	
Weight	9.9 lbs. (4.5 kg)	

Optional Needles



PN	Description
TA98780	Needle 2 mm x 150 mm (100 pcs./set)
TA98781	Needle 2 mm x 180 mm (100 pcs./set)
TA98782	Needle 3 mm x 180 mm (100 pcs./set)
TA98783	Needle 4 mm x 180 mm (50 pcs./set)

Premium Nitto Kohki needles out-perform competitors' needles ensuring optimal performance and trouble-free operation.

Anti-sparking beryllium copper and stainless steel needles available upon request. Consult factory before ordering.

PN	Description	Model
TP00338	Needle Supporter 2 mm	JT-20,
TP00337	Needle Supporter 3 mm	JEX-20
TQ05210	Needle Supporter 2 mm	AJC-16
TQ04554	Needle Supporter 3 mm	JC-16
TP00290	Needle Supporter 2 mm	JEX-24
TP02244	Needle Supporter 2 mm	JEX-24
TP02245	Needle Supporter 3 mm	JEX-24
TP14992	Needle Supporter 4 mm	JEX-28,
TP01499	Needle Supporter 2 mm	JEX-2800A
TP01461	Needle Supporter 3 mm	JEX-28,
TP01462	Needle Supporter 4 mm	JEX-2800A
TP16475	Needle Supporter 2 mm	EJC-32A
TP16301	Needle Supporter 3 mm	EJC-32A

SUPER KELEN

Industrial and shipboard pneumatic scalers



Features

- Quickly and efficiently removes rust, scale, paint, tar and concrete from most surfaces
- Ideal for industrial, maritime and shipboard cleaning and descaling operations
- Idle protection system, tool will not activate unless contacting work surface
- S-1000 – over 4-1/2' in length for extended reach applications and operator convenience
- Tool-less chisel installation and removal

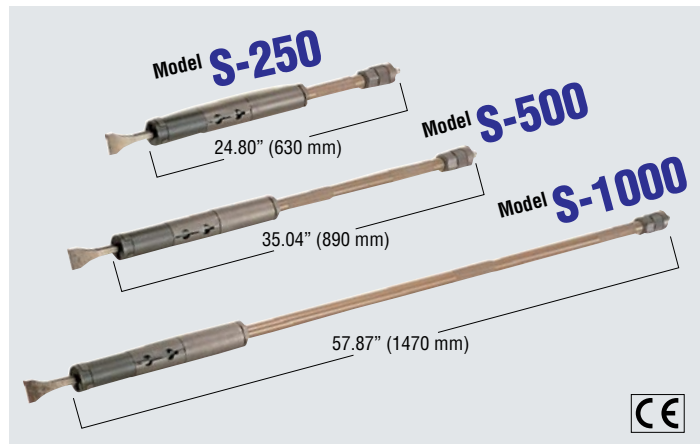

Specifications

Model	S-250	S-500	S-1000
Air Pressure	85 PSI	85 PSI	85 PSI
Air Consumption	9.5 CFM	9.5 CFM	9.5 CFM
Strokes per Minute	2,500 SPM	2,500 SPM	2,500 SPM
Shank Size	1/2" Square	1/2" Square	1/2" Square
Hose Size	3/8" ID	3/8" ID	3/8" ID
Weight	9.0 lbs.	10.4 lbs	13.4 lbs.

Accessories Included			
	• Scraper #2005 • Threaded Adapter M16 x NPT3/8"	• Scraper #2005 • Threaded Adapter M16 x NPT3/8"	• Scraper #2005 • Threaded Adapter M16 x NPT3/8"

Optional Chisels

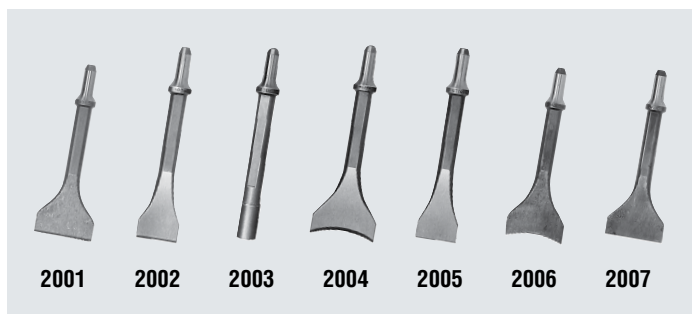

PN	Description	Qty
TP03645	2001 Scraper 2-3/8" (60 mm)	1 pc.
TP03646	2002 Scraper 1-1/2" (38 mm)	1 pc.
TP03647	2003 Blank Chisel	1 pc.
TP04010	2004 Concave Scraper 2-3/8" (60 mm)	1 pc.
TP04552	2005 Bend Scraper 1-1/2" (38 mm)	1 pc.
TP04553	2006 Concave Bend Scraper 2-3/8" (60 mm)	1 pc.
TP04554	2007 Bend Scraper 2-3/8" (60 mm)	1 pc.

AIR CHIPPER

Removes weld splatter quickly and easily



Features

- Ideal tool for quickly and efficiently removing weld splatter, rust and other debris from most surfaces
- Compact, heavy-duty construction for tough industrial applications
- Easy one-touch chisel installation and removal – NO tools required
- Idle protection system, tool will not activate unless contacting work surface, “ACH-16” only

ACH-16



CH-24



Specifications

Model	ACH-16	CH-24
Air Pressure	85 PSI	85 PSI
Air Consumption	5.3 CFM	7.1 CFM
Strokes per Minute	6,000 SPM	4,000 SPM
Shank Size	27/64" (10.5 mm) Round	1/2" Square
Hose Size	3/8" ID	3/8" ID
Weight	2.2 lbs.	3.7 lbs.

Accessories Included		
	<ul style="list-style-type: none"> • TQ03431 - Flat Chisel • Hose Nipple PT3/8" x 3/8" • Threaded Adapter PT3/8" x NPT3/8" 	<ul style="list-style-type: none"> • TP15166 - Curved Flat Chisel • Hose Nipple PT3/8" x 3/8" • Threaded Adapter PT3/8" x NPT3/8"

Optional Chisels

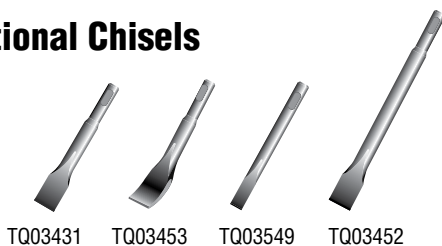

ACH-16 Chisels

PN	Description	Qty
TQ03431	Flat Chisel 3/4" x 4-3/4" (20 mm x 120 mm)	1 pc.
TQ03453	Curved Flat Chisel 3/4" x 4-3/4" (20 mm x 120 mm)	1 pc.
TQ03549	Flat Chisel 7/16" x 4-3/4" (11 mm x 120 mm)	1 pc.
TQ03452	Flat Chisel 3/4" x 7-1/16" (20 mm x 180 mm)	1 pc.

CH-24 Chisels

PN	Description	Qty
TP15234	Straight Flat Chisel 1/2" x 6-1/2" (12.7 mm x 165 mm)	1 pc.
TP15233	Flat Chisel 1" x 6-1/8" (25 mm x 155 mm)	1 pc.
TP15166	Curved Flat Chisel 1" x 6-1/8" (25 mm x 155 mm)	1 pc.

MYTON

Heavy-duty grinders for tough applications



Features

- Ideal for industrial and production grinding applications
- Variable Speed Control
- Side exhaust with noise reduction system
- Locking throttle lever helps prevent accidental start-up
- Great power/weight ratio
- Insulated handle for operator convenience and comfort
- Push button spindle lock for changing wheels (MLG-40, MLG-50, MLG-70)

MLG-25 Depressed center wheel 2-1/4"

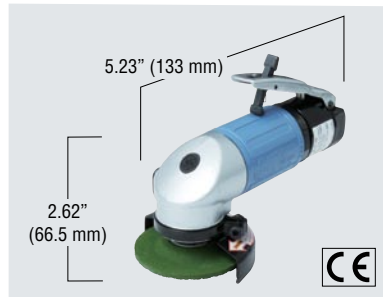

MLG-40 Depressed center wheel 4"

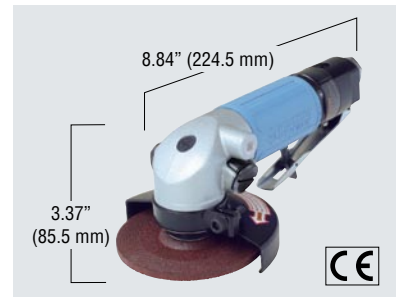

MAGW-40 Depressed center wheel 4"



MLG-50 Depressed center wheel 5"



MLG-70 Depressed center wheel 7"



Specifications

Model	MLG-25	MLG-40	MAGW-40	MLG-50	MLG-70
Air Pressure	85 PSI	85 PSI	85 PSI	85 PSI	85 PSI
Air Consumption (No Load)	14.8 CFM	15.9 CFM	24.0 CFM	24.7 CFM	24.7 CFM
Air Consumption (Load)*		32.1 CFM	29.0 CFM	38.8 CFM	38.8 CFM
Free Speed	19,000 RPM	13,000 RPM	13,000 RPM	11,000 RPM	7,600 RPM
Grinding Wheel Diameter	2-1/4" max.	4" max.	4" max.	5" max.	7" max.
Spindle OD Size	3/8"	5/8"	5/8"	7/8"	7/8"
Horsepower	0.29 HP	0.97 HP	0.78 HP	1.50 HP	1.50 HP
Hose Size	1/4" ID	3/8" ID	3/8" ID	3/8" ID	3/8" ID
Weight	1.3 lbs.	3.3 lbs.	3.4 lbs.	5.4 lbs.	5.4 lbs.

Accessories Included	MLG-25	MLG-40	MAGW-40	MLG-50	MLG-70
	<ul style="list-style-type: none"> • Threaded Adapter PT1/4" x NPT1/4" • 5 mm Allen Wrench • 19 mm Spanner • 80 grit Grinding Disc 	<ul style="list-style-type: none"> • Threaded Adapter PT3/8" x NPT3/8" • 5 mm Allen Wrench • 6 mm Allen Wrench 	<ul style="list-style-type: none"> • Threaded Adapter PT3/8" x NPT3/8" • 6 mm Allen Wrench • 17 mm Spanner 	<ul style="list-style-type: none"> • Threaded Adapter PT3/8" x NPT3/8" • 4 & 6 mm Allen Wrenches • Spanner Wrench • Side Handle Assembly • Wheel Guard Assembly 	<ul style="list-style-type: none"> • Threaded Adapter PT3/8" x NPT3/8" • 6 mm Allen Wrench • 8 mm Allen Wrench • Side Handle Assembly • Wheel Guard Assembly

* Governed models

Available Side Handles: MLG-40 (#TB08265), MAGW-40 (#TQ01051), MLG-50 (#TB08265 or #TB09680), MLG-70 (#TB08265 or #TB09680)

MYTON

Angle Sanders



Features

- Ideal for sanding and/or polishing on metal, aluminum, wood, plastic and many other materials
- Variable Speed Control
- Side exhaust with noise reduction system
- Locking throttle lever helps prevent accidental start-up
- Compact and lightweight design for working in confined spaces
- Great power/weight ratio
- Insulated handle for operator comfort and convenience
- Uses twist lock sanding discs for quick installation and removal (MLS-20)

MLS-20 Abrasive disc 1", 1-1/2" & 2"



MAS-40 Abrasive disc 4"



Specifications

Model	MLS-20	MAS-40
Air Pressure	85 PSI	85 PSI
Air Consumption (No load)	14.9 CFM	15.9 CFM
Free Speed	19,000 RPM	13,700 RPM
Sanding Disc Diameter	1", 1-1/2" or 2"	4" max.
Chuck Size	1/4"	N/A
Hose Size	1/4" ID	3/8" ID
Weight	1.3 lbs.	2.0 lbs.

Accessories Included	<ul style="list-style-type: none"> • Threaded Adapter PT1/4" x NPT1/4" • Two pieces of 14 mm Spanners 	<ul style="list-style-type: none"> • Threaded Adapter PT1/4" x NPT1/4" • Hose Barb NPT1/4" x 3/8" • 6 mm Allen Wrench • 17 mm Spanner
-----------------------------	---	---

Optional Accessories (MAS-40)	<ul style="list-style-type: none"> • TA91354 Side Handle • TQ00392 Adapter
--------------------------------------	--

AIR SONIC



Features

- Ideal for most deburring, finishing and grinding applications
- Precision machined with heavy-duty spindle (L-25B) and support bearings (L-35C)
- Rear exhaust with noise reduction system
- Suitable for industrial and production applications
- Locking throttle lever helps prevent accidental start-up
- Accepts most stone-type and rotary carbide burrs with 1/4" shanks

L-25B For all grinding, deburring and finishing jobs



L-35C Ideal for rotary carbide burrs



Specifications

Model	L-25B	L-35C
Air Pressure	85 PSI	85 PSI
Air Consumption	14.1 CFM	12.4 CFM
Free Speed	27,000 RPM	37,500 RPM
Chuck Size	1/4"	1/4"
Hose Size	1/4"	1/4"
Weight (without hose)	1.3 lbs.	1.0 lbs.

Accessories Included	<ul style="list-style-type: none"> • 1/8" Chuck Sleeve • Sample Grinding Stone • Spanner Wrench (14 mm) • Air Hose • Chuck Pin 	<ul style="list-style-type: none"> • 1/8" Chuck Sleeve • Sample Grinding Stone • Spanner Wrench (14 mm) • Air Hose
Optional Accessory	<ul style="list-style-type: none"> • 3/16" Chuck Sleeve 	<ul style="list-style-type: none"> • 3/16" Chuck Sleeve

AL-55 High Speed Rotation 56,500 RPM



Features

- Smooth high speed rotation and low vibration enables precision grinding
- Step-less speed change from 0 to 56,500 RPM meets a wide range of grinding applications
- Compact and light weight for comfortable operation over long periods of time
- Triangular grip fits operator's hand. Special plastic grip prevents cold hands and absorbs vibration
- Rear exhaust system



Specifications

Model	AL-55
Air Pressure	85 PSI
Air Consumption	6.0 CFM
Free Speed	56,500 RPM
Chuck Size	1/8"
Hose Size	1/4"
Weight (without hose)	0.55 lbs.
Accessories Included	<ul style="list-style-type: none"> • Sample Grinding Stone • Spanner Wrench (9 mm) • Spanner Wrench (7 mm)

* Stone type bits: Must be safety approved to operate at or above 56,500 RPM

AIR DRILL The power and performance you need to drill deeper and faster

ADR-65

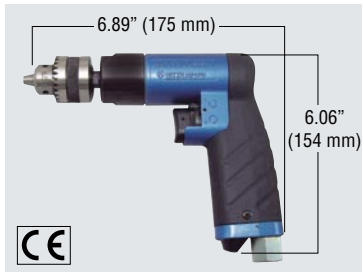

ADR-100



Features

- Ultra high power to weight ratio
- Ergonomically designed to reduce operator fatigue
- Variable speed control
- Reversible
- Designed for industrial and production applications

Reversible

Change rotation direction by turning the valve as indicated.

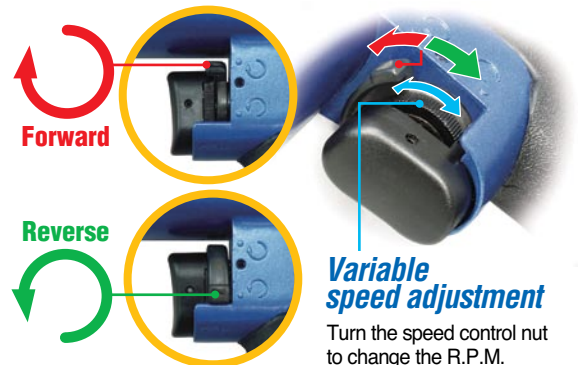

Specifications

Model	ADR-65	ADR-100
Air Pressure	85 PSI	85 PSI
Air Consumption (no load)	19.5 CFM	23.7 CFM
Free Speed	2,900 RPM	2,000 RPM
Chuck Size	1/4" (6.5 mm) max.	3/8" (10 mm) max.
Hose Size	3/8"	3/8"
Weight (without hose)	1.76 lbs.	2.42 lbs.

Accessories Included	<ul style="list-style-type: none"> • 1/4" (65 mm) Drill Chuck • Chuck Key • Threaded Adapter PT3/8" x NPT3/8" 	<ul style="list-style-type: none"> • 3/8" (10 mm) Drill Chuck • Chuck Key • Threaded Adapter PT3/8" x NPT3/8"
-----------------------------	--	--

BELTON Rear exhaust system

Ideal for sanding and grinding in narrow spaces, recessed areas and on curved surfaces



Features

- Lightweight materials for reduced user fatigue
- High-performance motor improves work output
- Throttle safety lever to prevent accidental start-ups
- Directable rear exhaust system
- 360° guard rotation to suit most applications
- Offset bracket assembly for sanding contoured surfaces
- Adjustable speed control
- Locking arm for quick belt changes

B-10CL

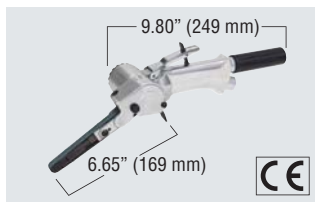

B-20CL

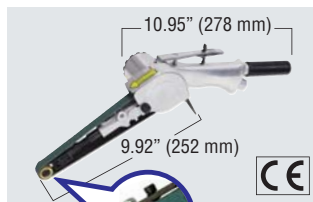

B-30CL

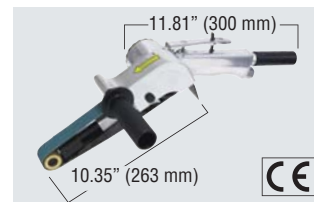

The Idle Pulley for B-20CL is supported on one side only.

Specifications

Model	B-10CL	B-20CL	B-30CL
Air Pressure	85 PSI	85 PSI	85 PSI
Air Consumption	14.2 CFM	17.0 CFM	29.1 CFM
Motor Free Speed	17,000 RPM	18,000 RPM	15,000 RPM
Belt Speed	3,470 FPM	9,086 FPM	7,577 FPM
Belt Size	3/8" x 13" (10 mm x 330 mm)	3/4" x 20-1/2" (20 mm x 520 mm)	1-3/16" x 21-1/4" (30 mm x 540 mm)
Hose Size	1/4"	1/4"	1/4"
Weight (without hose)	2.7 lbs.	2.9 lbs.	5.3 lbs.
Vibration Levels m/s ² (ISO20463)	1.21	1.32	0.56 at Grip 1.88 at Side Handle

Accessories Included

- Assortment of Sample Belts: 1 each of #60 mounted on tool plus 1 each of #60, #80, #100 and #120
- Threaded Adapter PT1/4" x NPT1/4"
- 2 mm Allen Wrench
- 4 mm Allen Wrench

- Assortment of Sample Belts: 1 each of #60 mounted on tool plus 1 each of #60, #80, #100 and #120
- Threaded Adapter PT1/4" x NPT1/4"
- 2.5 mm Allen Wrench
- Convex Shoe
- Silencer Sub Assembly

- Assortment of Sample Belts: 1 each of #60 mounted on tool plus 1 each of #60, #80, #100 and #120
- Threaded Adapter PT1/4" x NPT1/4"
- 5 mm Allen Wrench
- Side Handle Assembly
- Silencer Sub Assembly

Sanding Belts for BELTON Sanders

Optional Parts

No.	PN	Description
1	TB09997	Offset Bracket 10 Ass'y for B-10CL
2	TB10192	Offset Bracket 20 Ass'y for B-20CL
3	TB08150	Offset Bracket 30 Ass'y for B-30CL
4	TB09938	Finger Pad Ass'y for B-20CL
5	TB09996	Bracket 6 Ass'y for B10-CL
6	TP14770	Shoe 6 for B-10CL
7	TB10160	Idle Pulley Bracket A Ass'y for B-20CL
8	TB10191	Convex Shoe for B-20CL

B-10CL/BB-10A

3/8" x 13" or 10 mm x 330 mm Belt

Part #	Belt Grit	Qty
@U40001	#40	20 pcs./set
TP12438	#60	20 pcs./set
TP12439	#80	20 pcs./set
TP12440	#100	20 pcs./set
TP12441	#120	20 pcs./set
@U40002	#150	20 pcs./set
TP12543	#180	20 pcs./set

B-20CL

3/4" x 20-1/2" or 20 mm x 520 mm Belt

Part #	Belt Grit	Qty
TP01941	#40	20 pcs./set
TP01936	#60	20 pcs./set
TP01942	#80	20 pcs./set
TP01943	#100	20 pcs./set
TP01944	#120	20 pcs./set
@U40004	#150	20 pcs./set
TP02002	#180	20 pcs./set

B-30CL

1-3/16" x 21" or 30 mm x 540 mm Belt

Part #	Belt Grit	Qty
TP04074	#40	20 pcs./set
TP04084	#60	20 pcs./set
TP04085	#80	20 pcs./set
TP04086	#100	20 pcs./set
TP04078	#120	20 pcs./set
@U40006	#150	20 pcs./set
TP04511	#180	20 pcs./set



* for Abrasive belt width 6mm

BABY BELTON



Features

- Compact and lightweight, yet powerful
- Reversible rotation direction
- Ergonomically designed for left or right hand operator convenience

BB-10A

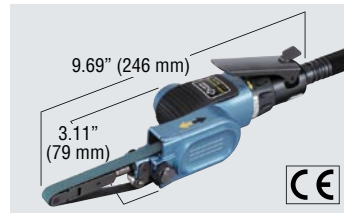

Specifications

Model	BB-10A
Air Pressure	85 PSI
Air Consumption	8.8 CFM
Motor Free Speed	16,000 RPM
Belt Speed	3,800 FPM
Belt Size	3/8" x 13" (10 mm x 330 mm)
Hose Size	1/4"
Weight (without hose)	1.3 lbs.

Accessories Included	<ul style="list-style-type: none"> • Assortment of Sample Belts, 1 Each of #100, #120, #180, and #240 grit • 1.5 mm Allen Wrench
-----------------------------	--

Ideal for deburring, chamfering, bead grinding, and polishing applications

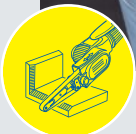
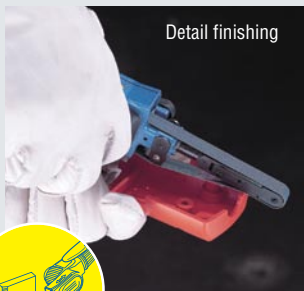
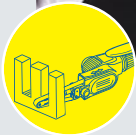

Lever position can be changed for right or left hand operator convenience.

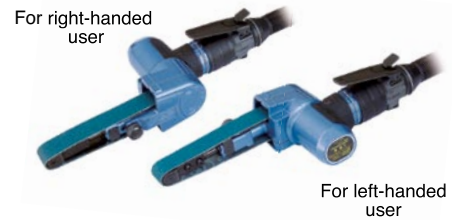

Belt rotation direction can be changed.



Forward



Reverse

ELECTRIC Beveling Tool

MINI BEVELER

EMB-0307B  Double insulation



Accessories Included

- 4 mm Allen Wrench
- Straight Cutting Tip
- (2) Hex. Nut M8
- (2) Hex. Socket Set Screws 8 mm x 25 mm
- (3) Pan Head Screws 5 mm x 10 mm
- Torx 15 (T-15) Spanner Wrench
- Chip Collector Box Assembly
- Spare Carbon Brush Assembly (1 Set)

PNEUMATIC Beveling Tool

MINI BEVELER

AMB-0307



Accessories Included

- Threaded Adapter PT3/8" x NPT 3/8"
- 3 mm Allen Wrench
- 4 mm Allen Wrench
- Straight Cutting Tip
- (2) Hex. Nut M8
- (2) Hex. Socket Set Screw 8 mm x 25 mm
- Torx 15 (T-15) Spanner Wrench

Features

- Lightweight design for portable edge beveling applications
- Ideal for beveling plate, outer pipe, tube and other profiles
- Designed to bevel stainless steel and carbon steel
- Adjustable to bevel angle from 15° to 45°
- Uses an indexable carbide insert
- Bevel depth up to 9/32" at 45°
- Outer edge pipe beveling > 12" (300 mm) minimum diameter
- Built-in chip collection box (EMB-0307B)
- Operates on single phase 230V (EMB-0307B)
- Powerful 1-1/2 horsepower double insulated motor (EMB-0307B)
- Quick release base allows easy access to cutting tip (EMB-0307B).

Specifications - EMB-0307B

Power Supply	220 V - 240 V A/C, 50/60 Hz
Rated Power Consumption	1010 W
Rated Current	4.6 A
Rated Duty Cycle	Continuous
Capacity (Mild Steel)	Up to 5/16" (7 mm) Bevel or 1/16" (2mm), 1/8" (3 mm), 5/32" (4 mm) Radius
Capacity (Stainless Steel)	Up to 1/8" (3mm) Bevel or 1/16" (2 mm), 1/8" (3 mm), 5/32" (4 mm) Radius
Bevel Angle	15 - 45 Degrees
Power Cord Length	13.1 Feet (4 Meters)
Weight	8.6 lbs. (3.9 kg)

Specifications - AMB-0307

Air Pressure	85 PSI
Air Consumption	31.8 CFM
Capacity (Stainless Steel)	Up to 5/16" (7 mm) Bevel or 1/16" (2mm), 1/8" (3 mm), 5/32" (4 mm) Radius
Capacity (Mild Steel)	Up to 1/8" (3mm) Bevel or 1/16" (2 mm), 1/8" (3 mm), 5/32" (4 mm) Radius
Bevel Angle	15 - 45 Degrees
Weight	6.4 lbs. (2.9 kg)

Available Cutting Tips for EMB-0307B and AMB-0307

Part #	Description
TV7A019	Straight Tip (2 pcs./set)
TV7A020	1/16" (2 mm) Radius Tip (2 pcs./set)
TV7A021	1/8" (3 mm) Radius Tip (2 pcs./set)
TV7A022	5/32" (4 mm) Radius Tip (2 pcs./set)

Bevel angle, width and radius

Angle α	EMB-0307B						AMB-0307					
	Stainless Steel(mm)			Mild Steel(mm)			Stainless Steel(mm)			Mild Steel(mm)		
	A	B	C	A	B	C	A	B	C	A	B	C
45°	3	3	4.2	7	7	9.9	3	3	4.2	7	7	9.9
30°	2.2	3.8	4.4	3.8	6.6	7.6	2.2	3.8	4.4	4	7	8.1
15°	1	3.8	3.9	1.5	5.6	5.8	1	3.8	3.9	2.2	8	8.3

Pneumatic Radial Chamfering Tool

CIRCUIT BEVELER

CB-01



Mild Steel
1C
Stainless Steel
0.5C

Accessories Included	<ul style="list-style-type: none"> • Indexable Insert: 2 pcs. (Installed) • Indexable Insert Set Screw: 2 pcs. (Installed) • Indexable Insert Set Screw: 2 pcs. (Extra Supply) • 2 mm Allen Wrench • Torx 6 (T- 6F) Wrench for Insert Set Screw • Threaded Adapter PT 1/4" x NPT 1/4"
-----------------------------	---

Optional Accessories	<ul style="list-style-type: none"> • TB09140: Guide Plate 78 Assembly • TB09143: Plate Assembly for Straight Edge Use (Must use with TB09140 Guide Plate 78 Assembly)
-----------------------------	---

Available Cutting Tips CB-01

Part #	Description
TV7A030	Cutting Tip (2 pcs./set) for Mild Steel (1 mm capacity)
TV7A031	Cutting Tip (2 pcs./set) for Stainless Steel (0.5 mm capacity)

Features

- Lightweight and compact for beveling and chamfering applications
- Uniquely designed to chamfer circular, elliptical and straight line profiles
- Chamfers exterior and/or interior edges
- Chamfer widths up to .04" (1mm) for CB-01/5/64" (2mm) for CB-02 at 45°
- Optional attachment PN#TB02437 available for chamfering and/or beveling thin materials (CB-02)
- Uses indexable carbide insert

Specifications CB-01

Air Pressure	85 PSI
Air Consumption	5.3 CFM
No Load Speed	28,000 RPM
Chamfering Capacity (Mild Steel)	Up to .039" (1 mm) Chamfer
Chamfering Capacity (Stainless Steel)	Up to .020" (0.5 mm) Chamfer
Chamfer Angle	45
Minimum Plate Thickness	.059" (1.5 mm) Maximum chamfer capacity is reduced to 0.5 mm when plate thickness is 1.5 mm
Minimum Radius	.118" (3 mm Radius)
Minimum Hole Diameter	.268" (6.8 mm) Diameter Hole
Weight	1.1 lbs. (0.5 kg)

Specifications CB-02

Air Pressure	85 PSI
Air Consumption	14.1 CFM
Chamfering Capacity (Mild Steel)	Up to 5/64" (2 mm) Chamfer or 1/16" (2 mm) Radius
Chamfer Angle	45°
Weight	4.0 lbs. (1.8 kg)

Pneumatic Radial Chamfering Tool

CIRCUIT BEVELER

CB-02



Mild Steel
2C
2R

Accessories Included	<ul style="list-style-type: none"> • Threaded adapter PT1/4" x NPT1/4" • Straight Cutting Tip • Hook Spanner • Cutting Depth Adjustment Gauge • Torx 9 (T-9) Spanner Wrench • Protective Cap
-----------------------------	--

Available Cutting Tips CB-02

Part #	Description
TV7A010	Straight Tip (2 pcs./set)
TV7A011	1/16" (2 mm) Radius Tip (2 pcs./set)

Chamfer angle, width and radius

Model	Chamfer Angle α	Mild Steel (mm)		Chamfer
		X	Y	
CB-01	45°	1	1	
CB-02	45°	2	2	
		Stainless Steel (mm)		
CB-01	45°	0.5	0.5	

Model	CB-02	
Material	Mild Steel	
Radius(mm)	2	

Chamfering range of operation

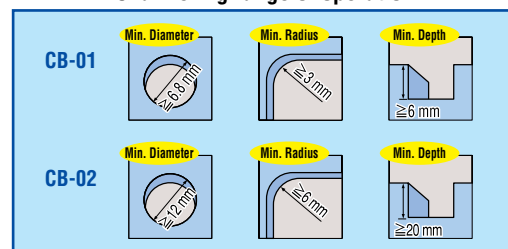

SUPER HAND

Fast, efficient filing, sanding and deburring tools

SH-100A



Features

- Eliminates time consuming manual hand-filing operations
- Ideal for industrial and production filing applications on steel, aluminum, brass, wood and other materials
- Unique and compact design delivers reduced vibration performance while reducing operator fatigue
- Interchangeable files • Rear exhaust system

ASH-900



Weight reduced by half for comfortable operation over long periods of time (compared to SH-100A)

SF-10 Rat Tail File



SF-11 Triangular Taper File



SF-12 Half Round File



SF-13 Flat Bastard File



Specifications

Model	SH-100A	ASH-900
Air Pressure	85 PSI	85 PSI
Air Consumption (No load)	8.5 CFM	7.1 CFM
Stroke Speed	3,700 SPM	6,300 SPM
Stroke Length	9 mm	9 mm
File Shank Size	6.3 mm	5.0 mm
Weight	2.4 lbs.	1.1 lbs.

Accessories Included

- Threaded Adapter PT1/4" x NPT1/4"
- 3 mm Allen Wrench
- SF-10 Rat Tail File
- SF-11 Triangular Taper File
- SF-12 Half Round File
- SF-13 Flat Bastard File
- Threaded Adapter PT1/4" x NPT1/4"
- 2.5 mm Allen Wrench
- SF-10 Rat Tail File
- SF-11 Triangular Taper File
- SF-12 Half Round File
- SF-13 Flat Bastard File

Optional Accessories

For Super Hand SH-100A, ASH-800 & ASH-900

PN	Description
TA9A222	SF-10 Rat Tail File (5 pcs./set)
TA9A223	SF-11 Triangular Taper File (5 pcs./set)
TA9A224	SF-12 Half Rounded File (5 pcs./set)
TA9A225	SF-13 Flat Bastard File (5 pcs./set)
TA91752	Rubber Pad Ass'y for SH-100A
TA94625	Chuck Assembly for SH-100A
TB04319	Sanding Pad Ass'y for ASH-800/ASH-900

TA94625

Chuck Ass'y for SH-100A (use with TA91752)

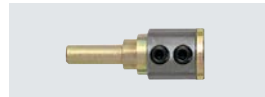

TA91752

Rubber Pad Ass'y for SH-100A



TB04319

Sanding Pad Ass'y for ASH-800/ASH-900



SUPER HAND LIGHT

Lightweight, ultra-low vibration filer for aluminum die cast and machined parts filing

SHL-40



LF-10 Rat Tail File



LF-11 Triangular Taper File



LF-12 Half Round File



LF-13 Flat File



Specifications

Model	SHL-40
Air Pressure	85 PSI
Air Consumption (No load)	2.5 CFM
Stroke Speed	9,000 SPM
Stroke Length	4 mm
File Shank Size	3 mm
Weight	0.88 lbs. (0.4 kg)

Accessories Included

- LF-13 Flat File
- 2 mm Allen Wrench
- Threaded Adapter PT 1/4" x NPT 1/4"

Optional Accessories

PN	Description
TB09652	LF-10 Rat Tail File (3 pcs./set)
TB09654	LF-11 Triangular Taper File (3 pcs./set)
TB09653	LF-12 Half Round File (3 pcs./set)
TB09651	LF-13 Flat File (3 pcs./set)

MICRO AIR HAND

Lightweight, ultra-low vibration filer for polishing and lapping operations

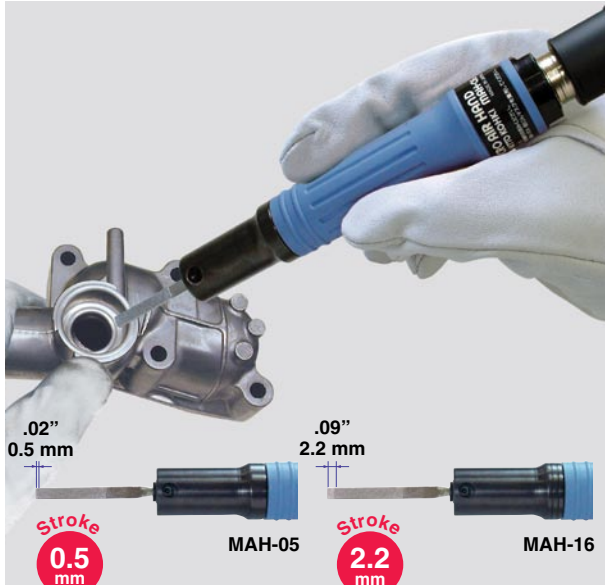

Diamond files (5pcs/set)

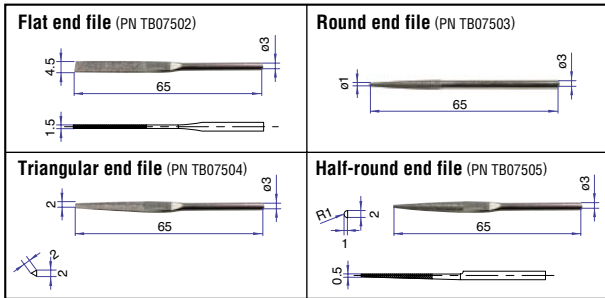

MAH-05/MAH-16



Specifications

Model	MAH-05	MAH-16
Air Pressure	85 PSI	85 PSI
Air Consumption (No load)	2.5 CFM	2.5 CFM
Stroke Speed	22,000 SPM	11,000 SPM
Stroke Length	0.5 mm	2.2 mm
File Shank Size	3 mm	3 mm
Weight	0.8 lbs.	0.8 lbs.

Accessories Included	<ul style="list-style-type: none"> • Threaded Adapter PT1/4" x NPT1/4" • 2 mm Allen Wrench • Flat End File • Round End File
-----------------------------	---

Vice Holder (PN TB07506)

This holder can be used for polishing and lapping applications by mounting ceramic stones, etc. (Max size: Thickness 3.2 mm x Width 20 mm)

SUPER SAW

SSW-110

Special double-piston system provides low vibration while improving cutting speed!



Optional Accessories



Part #	Description
TV7A005	32 TPI for Sheet Metal, Ferrous Metal (5 blades/set)
TV7A006	24 TPI for Ferrous Metal, Non-Ferrous Metal (5 blades/set)
TV7A007	18 TPI for Wood, Plastic, Non-Ferrous Metal (5 blades/set)
TV7A008	14 TPI for Wood, Plastic (5 blades/set)

Features

- Ideal for sawing and trimming operations on sheet metal, aluminum, plastic and other materials
- Suitable for automotive, fabrication, HVAC, electrical and woodworking applications
- Ultra lightweight construction with low vibration performance
- Optimized blade stroke for maximum cutting performance
- Powerful dual piston construction
- Locking throttle lever helps prevent accidental start-up

Specifications

Model	SSW-110
Air Pressure	85 PSI
Air Consumption (No load)	10.2 CFM
Stroke Speed	7,000 SPM
Stroke Length	11 mm (7/16")
Weight	1.37 lbs.

Accessories Included	<ul style="list-style-type: none"> • Threaded Adapter PT1/4" x NPT1/4" • 3 mm Allen Wrench • (2) Sample 32 TPI Saw Blades
-----------------------------	--

FREE SANDER

Super lightweight,
low-vibration design



Features

- Ideal for sanding and surface finishing on wood, metal, plastic and other materials
- Lightweight design with minimal vibration
- High output and low air consumption motors produce high speed orbits for swirl-free finishes
- Oil free design
- Suitable for industrial and production applications



Powerful turbine motor

Produces ultra-high speed orbits for super-fine finishing of all materials

(FS-100C)

FS-100C

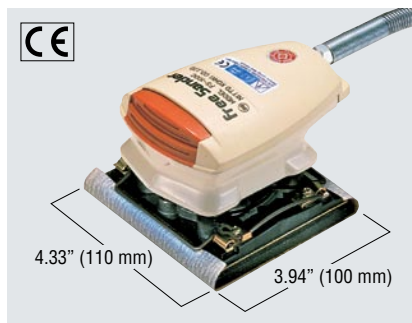

FS-50A



Specifications

Model	FS-100C	FS-50A
Air Pressure	85 PSI	85 PSI
Air Consumption	7.1 CFM	4.9 CFM
Free Speed	20,000 RPM	15,000 RPM
Orbit Diameter	1/16"	3/64"
Pad Size	4" x 4-3/8"	3" x 3-3/16"
Paper Size	4-1/2" x 5-1/2" (1/4 Sheet)	2-3/4" x 4-1/2" (1/8 Sheet)
Weight	1.1 lbs.	1.1 lbs.

Accessories Included

- | | |
|---|---|
| <ul style="list-style-type: none"> • Threaded Adapter PT1/4" x NPT1/4" • Hose Sub Assembly • Sample Sanding Papers | <ul style="list-style-type: none"> • Threaded Adapter PT1/4" x NPT1/4" • Hose Sub Assembly • Sample Sanding Papers |
|---|---|

LINE SANDER

Ideal for inline and grain sanding applications



Features

- Ideal for most inline and profile sanding applications
- Compact and lightweight 1.6 lb. design
- Low vibration and minimal noise output
- Suitable for sanding steel, aluminum, wood, plastic and other materials
- Available with dust collection assembly

LS-10

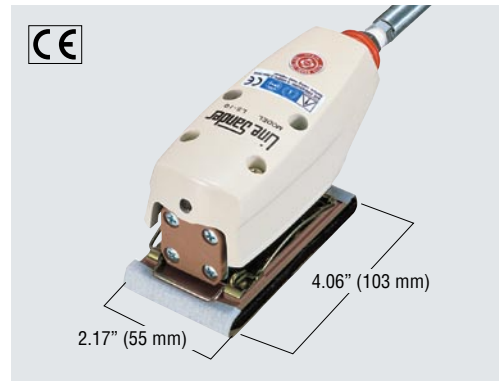

Double Piston Alignment

Special double-action minimizes both noise and vibration.

Specifications

Model	LS-10
Air Pressure	85 PSI
Air Consumption	3.9 CFM
Stroke Speed	4,000 SPM
Stroke Length	5/32"
Pad Size	2-5/32" x 4-1/16"
Paper Size	2-1/4" x 5-1/2" (1/8 Sheet)
Weight	1.6 lbs.

Accessories Included

- Threaded Adapter PT1/4" x NPT1/4"
- Hose Barb
- Hose Sub Assembly
- Block Pad Assembly
- Sample Sanding Papers

Optional Accessories

- TB02244: Dust Collector

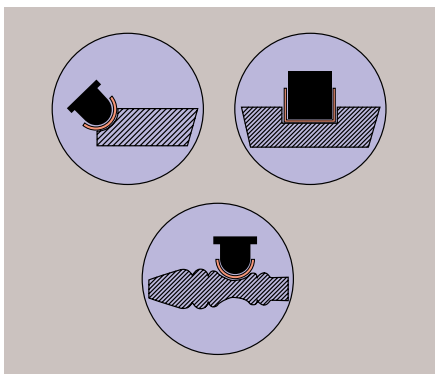

Special Sanding Pad

The Block Rubber Pad Assembly can be easily trimmed to conform to the shape being worked and is available as an accessory.

ORBITAL SANDER

Heavy-duty and powerful with adjustable speed regulator



OSV-60A



Features

- Powerful 3/4 horsepower dual action for tough applications
- Also available with 5" pad (OSV-50A)
- Standard with dust extraction system
- Rugged construction for reliable performance

Specifications

Model	OSV-60A
Air Pressure	85 PSI
Air Consumption (No load)	24.1 CFM
Free Speed	8,500 RPM
Orbit Diameter	3/8"
Paper Size	6" Diameter
Pad Type	PSA
Horsepower	.75 HP
Weight	4.4 lbs.

Accessories Included

- Threaded Adapter PT1/4" x NPT1/4"
- Dust Collection Assembly with Dust Bag
- Spanner Wrench (17 mm)

Random orbital action creates a professional finish

By offsetting the sanding pad shaft, fast aggressive sanding is achieved while dramatically reducing swirl patterns. Speed adjustments allow for the best speed for the best job.

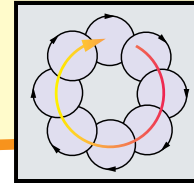

PALM ORBITAL SANDER

Ergonomic lightweight design



APS-125/150



For Self-Vacuum & Central Vacuum

The non-vacuum model is available from stock and can easily be modified to self-vacuum or central vacuum.

Self-Vacuum



Central Vacuum



Features

- Compact and lightweight 1.6 lb. design
- Ergonomically designed for operator convenience and comfort
- Powerful high speed 10,000 RPM motor
- Ultra small orbital action for high quality swirl-free finishes
- Available with 5" or 6" pads
- Variable speed control

Applications

- Feather edging, metal preparation, and finishing work on body filler.
- Curved surface sanding and corner rounding in wood work.

Specifications

Model	APS-125	APS-150
Air Pressure	85 PSI	85 PSI
Air Consumption	15.9 CFM	15.9 CFM
Free Speed	10,000 RPM	10,000 RPM
Orbit Diameter	3/16"	3/16"
Paper Size	5" Diameter	6" Diameter
Pad Type	PSA	PSA
Spindle Thread	5/16"-24	5/16"-24
Horsepower	.37 HP	.37 HP
Weight	1.52 lbs.	1.59 lbs.

Accessories Included

- Threaded Adapter PT1/4" x NPT1/4"
- Spanner

Be sure to read and understand all safety precautions mentioned below and to follow the instructions given to operate each Nitto Kohki brand tool as stated in the operator's manual. Keep operators manual close by when operating machines or tools for reference of safe operation and precautions.

Safety Precautions

Failure to observe the following warnings may cause a potentially hazardous situation, which if not corrected, could result in serious injury or death. To prevent the risk of fire, electric shock, and/or personal injury, proper safety guidelines should be followed at all times.

Warning for ALL Machines and Tools

- Always keep the work area free from clutter and potentially dangerous conditions such as hanging power cords, working debris, air hoses, and garbage to prevent accidents from occurring.
- Consider proper working environments for each tool carefully. Do not expose tools to extreme amounts of moisture or direct contact with water or rain. Keep area well lit at all times to prevent hidden dangers and never operate the equipment near flammable liquids or in gaseous or explosive atmospheres.
- Keep all tools and tool accessories away from children and all unauthorized personnel. Serious injury or possible death may result from machines being handled by children.
- Properly store machines and accessories while not in use. They should be kept in a dry, locked-up location out of reach of children or unauthorized personnel.
- Improper or negligent use of tools will cause increased maintenance costs, and the amount of time in which to complete the job. Always let the tool do the work at the rate of which it was designed. Best performance is always achieved by reading and understanding the proper operation of each machine or tool.
- Always wear safety glasses and protective hand and foot wear during or around operating tools. Wear a protective hair covering to contain long hair. Do not wear loose clothing and/or accessories as they may be caught in moving parts and inflict serious injury or possible death.
- Wear respiratory protection when working in an environment where dust particles are generated during operation.
- Do not over-reach or allow yourself to become unstable during tool operation and always maintain a correct posture.
- Use clamps or a vise to secure the work piece tightly and eliminate vibration. Never hold the work piece with your hands, keep both hands on the tool for increased productivity.
- Use the right tool or machine that can complete the job within its specifications. Do not attempt to adapt smaller machines or tools to complete a job designed for heavy-duty equipment. Do not use the tools for other than what they were designed for. There is a right tool for each job, be aware of tool limitations and never overload.
- Make sure to inspect all external screws, nuts, bolts and attached accessories are fastened tightly and secure prior to each use. All moving parts should be free from obstruction and allowed to operate smoothly. Any damaged or missing parts should be repaired or replaced by the sales agent or distributor from which the tool was originally purchased. Do not use machines or tools which cannot be activated or stopped with a power switch or lever.
- Do not use any machine with a damaged, frayed, cut, or deteriorated power cords or air hoses. Always replace at the first sign of damage.
- Always remove all tools required to adjust, add, or remove parts from tools prior to use to prevent tool damage or user injury.
- Always avoid an unexpected start by having all power buttons or levers in the off position prior to attaching to a power or air supply. Never carry tools with your finger on the on/off switch or lever when the power or air supply is attached.
- Do not use the power or air supply lines to move, carry or support the tool during usage or transportation. Do not place the power or air line near a heat source, oil, water, or items with sharp edges.
- Never leave a machine or tool running unattended. Keep a firm grip on the designated areas of the machine or tool until it comes to a complete stop. Always turn the power switch or lever to the off position and disconnect from the power source when not in use.
- Do not disassemble or modify a tool to complete a job other than what it was designed for. This will void any warranty on the equipment and may cause serious personal injury or possible death.
- Maintenance is necessary for all machines and tools. Always maintain blades and cutters properly and replace when edges become damaged or are not sharp enough for safe operation. Follow the instruction manual for lubrication needs and adjustment points if applicable. Check the power and air supply lines periodically and change accordingly to safety regulations. If an extension line is adopted, always make sure that it meets or exceeds tool requirements for amperage or air supply before using and is rated for outdoor usage. Change supply lines whenever they are found to be defective or damaged. Keep the grip and handles dry and clean of grease or oil so that it will not disturb proper operation.
- Switch off and disconnect from power source before servicing equipment or changing accessories.
- Be alert and pay close attention to the work being performed at all times. Do not operate machines or tools when heavily fatigued. Users should be aware of all circumstances surrounding their application.
- Use only recommended parts and accessories as per individual machine or tool operator manuals. Use of improper accessories or attachments may result in serious injury or possible death.
- All repairs and services must be performed by authorized Nitto Kohki dealers or technicians.
- Do not deface or remove any label, warning indicator, or nameplate associated with each machine or tool.

Notice for Electric Tools

- The power source must be limited to the individual tools specifications as stated on the nameplate or instruction manual.
- Make sure that all machine and power tools are properly grounded at all times (excludes double-insulated tools). Always use a GFCI (Ground-Fault-Circuit-Interrupt) to protect the user and surrounding persons from electric shock.
- Be aware of low voltage situations. Improperly gauged extension cords or power cords used or shared with other electrical devices will cause all tools on the line to not run at optimal performance. This condition may result in damage to the machine and/or operator.

Notice for Air Tools





- Air pressure at the inlet of the tool must not exceed 0.6 MPa (85 PSI).

HI CUPLA / HI CUPLA 200 (One-touch connection & Big flow rate type)





- One-way shut-off cupla with an automatic shut-off valve in the socket.
- Important parts are hardened for excellent wear resistance and durability.

Plug P

For hose connection		40PH	For 1/2" hose	
17PH	For 1/4" hose	400PH	For 1/2" hose	
20PH	For 1/4" hose	600PH	For 3/4" hose	
30PH	For 3/8" hose	800PH	For 1" hose	
For female thread connection		40PM	For Rc 1/2"	
10PM	For Rc 1/8"	400PM	For Rc 1/2"	
20PM	For Rc 1/4"	600PM	For Rc 3/4"	
30PM	For Rc 3/8"	800PM	For Rc 1"	
For male thread connection				
20PF	For R 1/4"	400PF	For R 1/2"	
30PF	For R 3/8"	600PF	For R 3/4"	
40PF	For R 1/2"	800PF	For R 1"	
For male thread connection (parallel thread)				
20PFF	For G 1/4"			

Socket S

For hose connection		40SH	For 1/2" hose	
17SH	For 1/4" hose	400SH	For 1/2" hose	
20SH	For 1/4" hose	600SH	For 3/4" hose	
30SH	For 3/8" hose	800SH	For 1" hose	
For female thread connection		40SM	For Rc 1/2"	
10SM	For Rc 1/8"	400SM	For Rc 1/2"	
20SM	For Rc 1/4"	600SM	For Rc 3/4"	
30SM	For Rc 3/8"	800SM	For Rc 1"	
For male thread connection				
20SF	For R 1/4"	400SF	For R 1/2"	
30SF	For R 3/8"	600SF	For R 3/4"	
40SF	For R 1/2"	800SF	For R 1"	

For hose connection		200-17SH	For 1/4" hose	200-40SH	For 1/2" hose
200-20SH	For 1/4" hose				
200-30SH	For 3/8" hose				
For female thread connection					
200-20SM	For Rc 1/4"				
200-30SM	For Rc 3/8"				
200-40SM	For Rc 1/2"				
For male thread connection					
200-20SF	For R 1/4"				
200-30SF	For R 3/8"				
200-40SF	For R 1/2"				

Specifications

Type	Hi Cupla	Hi Cupla 200
Body material	Steel (chrome-plated)	Steel (chrome-plated)
Size	1/8", 1/4", 3/8", 1/2", 3/4", 1"	1/8", 1/4", 3/8", 1/2"
Working pressure	1.5 MPa	1.0 MPa
Pressure resistance	2.0 MPa	1.5 MPa
Packing material	NBR	NBR
Working temp.range	-20°C - 80°C	-5°C - 60°C

HI CUPLA ACE





- Plastic Cuplas with a built-in locking mechanism!
- Pressure ratings comparable to steel Cuplas.







Specifications

Body material	Engineering plastics
Size	1/4", 3/8", others
Working pressure	1.5 MPa
Pressure resistance	2.0 MPa
Packing material	NBR
Working temp.range	-5°C - 60°C

Plastic Plug P

For hose connection (PH)		
20PH-PLA	For 1/4" hose	
30PH-PLA	For 3/8" hose	
For female thread connection (PM)		
20PM-PLA	For Rc 1/4"	
30PM-PLA	For Rc 3/8"	
For urethane hose with spring nut connection (PNG)		
50PNG-PLA	For 5 ID x 8 OD hose	
65PNG-PLA	For 6.5 ID x 10 OD hose	
85PNG-PLA	For 8.5 ID x 12.5 OD hose	
For male thread connection (PF)		
20PFF-PLA	For G 1/4"	

Hi Cupla Ace Socket S

For hose connection (SH)		
HA-20SH	For 1/4" hose	
HA-30SH	For 3/8" hose	
For female thread connection (SM)		
HA-20SM	For Rc 1/4"	
HA-30SM	For Rc 3/8"	
For urethane hose with spring nut connection (SNG)		
HA-50SNG	For 5 ID x 8 OD hose	
HA-65SNG	For 6.5 ID x 10 OD hose	
HA-85SNG	For 8.5 ID x 12.5 OD hose	
Hi Cupla Ace T type (for 2 branches)		
HA-T	20P-PLA / HA-65S x 2	

"delvo" Electric Screwdrivers, Linear-motor-driven Free Piston System

delvo Professional Tools for High Technology

NITTO KOHKI "delvo" Electric Screwdrivers are high-quality tools for professional use, with special emphasis on precise control of torque and long life. They apply just the correct amount of torque – with sure, positive control always at your fingertips. They're smooth and shockless in operation, too. NITTO KOHKI's customer-oriented service system is directly connected to sales agents to ensure that you can use "delvo" Electric Screwdrivers with confidence.

delvo Models

- DLV7300 Series
- DLV7500/8500 Series
- DLV7000/8000 Series
- DLV7100/7200/8100/8200 Series
- DLV3100/3300 Series
- DLV5720/5720H/5740/5740H/5750 Series
- DLV5800 Series
- DLV30SP/30HP-MKG (with built-in brushless motors)



Linear Motor Driven Free Piston System

MEDO USA, Inc. offers linear motor-free piston system air compressors and vacuum pumps, featuring unique, quiet, oil-free operation with high reliability and long life. This design theory uses a resonant spring mass piston assembly energized by a pulsating magnetic field. The functionally elegant design, with only one moving part, is ideally suited for a variety of applications.



About us

Nitto Kohki U.S.A., Inc. was founded in 1969 to provide sales and service of machine tools and quick-connecting fluid couplings that are designed and manufactured by Nitto Kohki Company, Ltd. located in Tokyo, Japan. We attained a position at the forefront of the industry, pioneering the development of unique, high quality products based on the core technologies of fluid mechanics, precision engineering and, more recently, electronic engineering. Through our products, Nitto Kohki has

consistently offered customers advantages in terms of labor savings, improved working environments and efficient manufacturing.

Nitto Kohki's products fulfill vital roles in fields ranging from applications in the construction industry and the automotive industry, to high-tech engineering. We will continue to capitalize on these favorable trends and precisely meet market needs in a timely manner.



Nitto Kohki Worldwide

Nitto Kohki Group... a corporation rising to the challenge of creating products and building a better tomorrow by responding to the needs of today. With the incessant challenge of developing energy and labor saving technology, we will contribute to society in a variety of ways through original technology that corresponds to users' needs.



JQA-EM4057
NITTO KOHKI CO., LTD.
Headquarters
Research Center

JQA-2042
NITTO KOHKI CO., LTD.
Machine Tools Division

Visit nittokohki.com for live demo session videos!



Nitto Kohki U.S.A., Inc.
46 Chancellor Drive, Roselle, IL 60172 U.S.A.
Phone: (630) 924-9393 Toll Free: (800) 323-8828 Fax: (630) 924-0303
info@nittokohki.com www.nittokohki.com

DISTRIBUTED BY